

Large Enterprise Solutions



Copyright 2001 - 2005
MICROS Systems, Inc.

9700 V.3.0 System Setup Manual

9700 HMS

Declarations

Warranties

Although the best efforts are made to ensure that the information in this manual is complete and correct, MICROS Systems, Inc. makes no warranty of any kind with regard to this material, including but not limited to the implied warranties of marketability and fitness for a particular purpose. Information in this manual is subject to change without notice. No part of this manual may be reproduced or transmitted in any form or by any means, electronic or mechanical, including photocopying, recording, or information recording and retrieval systems, for any purpose other than for personal use, without the express written permission of MICROS Systems, Inc.

MICROS Systems, Inc. shall not be liable for errors contained herein or for incidental or consequential damages in connection with the furnishing, performance, or use of this manual.

Trademarks

Windows is a registered trademark of Microsoft Corporation.

FrameMaker is a registered trademark of Adobe Corporation.

Printing History

New editions of this manual incorporate new and changed material since the previous edition. Minor corrections and updates may be incorporated into reprints of the current edition without changing the publication date or the edition number.

Edition	Month	Year	Software Version
1st	September	2005	3.0

Table of Contents

Preface

vi	Why Read This Manual?
vii	Finding Additional Information
viii	Notation Conventions

Chapter 1 - System Overview

1-2	Communications
1-6	Hardware Requirements
1-7	Hardware Recommendations
1-8	MICROS Eclipse Workstation
1-8	MICROS Workstation 4 (WS4)
1-9	MICROS Keyboard Workstation 4 (KWS4)
1-9	Mobile MICROS HHT
1-10	Epson TM88 Thermal Printer
1-10	Epson U200B
1-11	MICROS Network Cluster Controller (NetCC)

Chapter 2 - 9700 Software Platform Installation

- 2-2 Installing Windows
- 2-2 Software Licensing
- 2-3 System Security
- 2-8 Post-Windows Setup
- 2-11 Microsoft® SQL Server™ 2000 (SP3) or Oracle®9i
- 2-19 Installing the 9700 HMS Application
- 2-46 Installing 9700 V. 3.0 Components on Clients
- 2-59 Starting the 9700 System
- 2-60 Configuring Network and Local Printing
- 2-70 Configuring WinStation Client Workstations
- 2-82 Configuring Workstation 4 (WS4) Clients
- 2-85 Configuring NetCCs
- 2-99 Backing Up the System: MS-SQL Maintenance Plans

Chapter 3 - Software Maintenance

- 3-2 Upgrading to 9700 V. 3.0
- 3-3 MS-SQL Upgrades
- 3-33 Oracle Upgrades
- 3-63 Upgrading MICROS Peripheral Applications

Index



Preface

In This Chapter

In this preface, you will find information about the organization, conventions, and contents of this manual.

Why Read This Manual?	-vi
Finding Additional Information	-vii
Notation Conventions	-viii

Why Read This Manual?

Purpose

The purpose of this manual is to provide you with instructions on how to install and configure the 9700 HMS hardware and software.

This manual does *not* provide guidance for modifying or programming the 9700 System's database or servicing the 9700 System.

Who should use this manual?

This manual is intended for the following audiences:

- MICROS Installers/Programmers
- MICROS Dealers
- MICROS Customer Service Representatives
- MICROS Training Personnel
- MIS Personnel

This manual assumes that you have the following knowledge or expertise:

- Operational understanding of PCs
- Understanding of basic network concepts
- Experience with Microsoft® Windows® 2000 Server or Server 2003
- Experience with Microsoft® SQL Server™ or Oracle®9i
- Understanding of POS terminology and concepts

Familiarity with the MICROS HMS 9700 software and peripherals (e.g. installation experience, classes provided by the MICROS Training Department, etc.) is strongly recommended.

Finding Additional Information

The MICROS 9700 HMS System's documentation suite is composed of hardware and software manuals which support the 9700 System.

Our documentation is provided in Portable Document Format (.PDF) and online help (.CHM) files. You must have Adobe® Acrobat® Reader (conveniently located in the Adobe Reader folder on the 9700 Version 3.0 Companion CD, or available online at <<http://www.adobe.com>>) installed to view the .PDF files. All software documentation is available on the 9700 Version 3.0 Companion CD. You can view the documentation from there, or download the documentation to any PC.

The 9700 Version 3.0 Companion CD is also available online through the MICROS 9700 V. 3.0 product page.

Notation Conventions

Keys

Throughout this manual, keys on a PC keyboard are shown in bold and enclosed in square brackets. Examples:

[Enter]

[Shift]

[Page Up]

Prompts

Messages that may appear on the screen when programming are shown in Courier 11pt italics. Example:

Select Menu Item Range

Design and Production

This manual was written with Adobe® FrameMaker® v. 6.0. Some illustrations and diagrams were designed in CorelDRAW®, Adobe® Photoshop®, and Microsoft® Visio®.



1

System Overview

In This Chapter

This chapter introduces 9700 System communication, how the system can be configured, and the recommended hardware to use.

Communications.....	1-2
Hardware Requirements	1-6
Hardware Recommendations	1-7
MICROS Eclipse Workstation	1-8
MICROS Workstation 4 (WS4)	1-8
MICROS Keyboard Workstation 4 (KWS4).....	1-9
Mobile MICROS HHT.....	1-9
Epson TM88 Thermal Printer	1-10
Epson U200B	1-10
Recommended Communications Option	1-11

Communications

The 9700 System maintains an open design philosophy, allowing the system to communicate with MICROS peripherals, non-MICROS equipment, and other computer systems. To achieve this capability, the 9700 System provides several communication pathways for exchanging information:

- ◆ Local Area Network (LAN)
- ◆ Property Management System (PMS) Interface
- ◆ Table Management System (TMS) Interface
- ◆ Intelligent Device Network (IDN)
- ◆ Credit Authorization/Electronic Draft Capture (CA/EDC)
- ◆ Input Devices
- ◆ Video Security System (VSS)

Local Area Network (LAN)

Every network must be connected via some sort of transmission medium or cabling. In a 9700 System, multiple PCs communicate with each other over a Local Area Network (LAN).

A LAN comprises a series of cables that connect computers together within a small area (room, building, site) for the purpose of sharing data, files, and print information between them. A special device, called a hub, is used to create the common connection the PCs need to communicate. Please note, not all wired LANs have hubs. Also, some LANs are wireless or include wireless components.

Property Management System (PMS) Interface

The PMS (Property Management System) interface allows the 9700 System to communicate with a Property Management System (e.g., a Fidelio Front Office or other hotel front desk system). The 9700 System is designed to communicate with up to four PMSs per Revenue Center and 128 per system. Two or more Revenue Centers may access the same PMS. Communication is established using the COM port on the PC or via TCP/IP.

Table Management System (TMS) Interface

The Table Management System (TMS) is a computerized seating management system that helps organize table usage and assignment in a restaurant. A TMS can be used to open checks in the 9700 System. The 9700 System has the ability to communicate with a TMS via the RS232 ports on the PC or TCP/IP.

Intelligent Device Network (IDN)

Each system can have a series of Stand-alone Roll and Slip Printers, Line Printers, and Video Display Units attached.

Order Printers

Order printers (usually used for remote order receipts) are usually connected in a “daisy-chain” directly to a single channel on the NetCC or RCC controller, or a User Workstation.

Line Printers

Line printers, which are used to print back-office reports, can be connected on any serial port on the PC, parallel port on the PC, or via the network (IPCC). For more information, refer to “Configuring Network and Local Printing” on page 2-60.

See also “Printers” in Section P of the *9700 A to Z Feature Reference Manual*.

Video Display Unit (VDU)

VDUs display food orders on a CRT screen (usually in the kitchen). A VDU can be used with or as a replacement for remote printers. A series of VDUs can be connected, in daisy-chain fashion, to a channel through the RCC controller.

Credit Authorization/Electronic Draft Capture (CA/EDC)

Credit Authorization (CA) is a 9700 option that automatically transmits a request for credit approval to a credit card center before accepting a credit card for payment. Electronic Draft Capture (EDC) automatically transfers a record of daily credit card transactions to a servicing credit card processor.

For more information, refer to the *CA/EDC Driver User's Manual* and the *CA/EDC Driver Installation Manual* that are related to the CA/EDC Driver Software the establishment is using.

Input Devices

Bar Code Reader

A *Barcode Reader* allows an operator to enter (scan) items for sale without having to read information from the item, or find the item on the keyboard. This is especially useful in a retail establishment where a great number of items are available.

For more information, refer to the *9700 Hardware Installation Manual*, and the *User's Maintenance Guide*.

Liquor Dispensing System (LDS) Interface

The 9700 System's LDS (Liquor Dispensing System) Interface allows the 9700 to receive sales posting information from a Liquor Dispensing System. The LDS Interface also integrates the LDS control features with the point-of-sale system's controls, creating a means to:

- ◆ Verify that all poured drinks were posted to a guest check.
- ◆ Balance the liquor inventory against the sales of liquor menu items using 9700 reports.

There are two types of LDS interfaces: North American LDS (NA LDS), and International LDS (INT LDS).

For more information, refer to "Liquor Dispensing Interface" in Section L of the *9700 A to Z Feature Reference Manual*.

Hardware Requirements

Shown below are the basic requirements for installing the 9700 HMS application on your PC:

- ◆ PC configured according to the parameters detailed in the “9700 Version 3.0 Server Sizing” document, located on the MICROS product page.
- ◆ Windows 2000 Server operating system with Service Pack 4 installed (this must be the Server edition, not Professional), or Windows 2003 Server.
- ◆ Internet Explorer 6.0 or higher (the 9700 HMS installation process will install IE 6.0 if it is not already installed).
- ◆ PC must use static IP address.
- ◆ An Uninterruptible Power Supply (UPS) is strongly recommended on every MICROS 9700 System to allow the server to shutdown safely in the event of a power outage.

Note *If you are installing multiple adapters (NICs), make sure the client NIC is listed first:*

- *From the Windows Desktop, right-click on **My Network Places***
 - *Select **Properties***
 - *Select the **Advanced** tab*
 - *Select **Advanced Settings***
 - *On the **Adapters and Bindings** tab, highlight the client NIC and move it up to the top of the list*
 - *Click **OK** to save the changes*
 - *Reboot the server*
-

Hardware Recommendations

Listed below are the hardware components recommended by MICROS. For detailed information on each component, refer to the *9700 HMS Feature Overview Manual*.

Server Options

MICROS Systems, Inc. requires all sites meet the minimum requirements for server configuration listed on the MICROS Product Page. For more product-specific information, go to the Hewlett-Packard Web site at www.hp.com, or contact your MICROS sales representative.

Terminal Options

MICROS recommends the following terminal options for a 9700 System:

- ◆ MICROS Eclipse PC Workstation
- ◆ MICROS Workstation 4
- ◆ MICROS Keyboard Workstation 4
- ◆ Mobile MICROS HHT

You will find a brief description of each of these terminals starting on page 1-8. For current terminal recommendations, please consult the MICROS Product Page, or contact your MICROS sales representative.

Printer Options

MICROS recommends the following printer options for a 9700 System:

- ◆ Epson TM88 Thermal Printer
- ◆ Epson U200B

You will find a brief description of each of these printers starting on page 1-10. For current printer options, please consult the MICROS Product Page, or contact your MICROS sales representative.

MICROS Eclipse Workstation

The **Eclipse Workstation** DOS Client is a popular hardware offering supported by the 9700 HMS System. Its compact design and advanced open architecture make the Eclipse a top choice for POS Systems in restaurants of any type and size.

The Eclipse is an easy-to-use touchscreen personal computer designed for point-of-sale use. With its small footprint and all-in-one design, the Eclipse is an excellent fit for locations where space is at a premium. The user display, available in both a 12.1" and 15.0" display, and CPU are integrated into a sleek single unit for simple set up and maintenance. The spill-resistant touchscreen is built to stand up to harsh environments and heavy use in the hospitality industry, and the unit's rugged good looks blend unobtrusively into any decor.

Built around the Intel® Celeron™ and Pentium® III processors, the Eclipse is the most powerful POS workstation available today. It supports Microsoft's most popular operating systems, and offers an incredible amount of flexibility to connect most any peripheral device. The Eclipse is also backward compatible with all of MICROS's POS peripheral devices, so there is no need for existing customers to buy new printers, pole displays, or cash drawers.



MICROS Workstation 4 (WS4)

The **Workstation 4 (WS4)** is MICROS' latest addition to the workstation family. The inexpensive and durable WS4 is equipped with the Microsoft® Windows® CE .NET operating system, and can easily be integrated into any existing 9700 System, with either the WinStation or SAR application installed. The WinStation and SAR functionality is no different than in previous versions.

Similar in appearance to the MICROS UWS/3, the low profile WS4 adds an Active Color LCD, 10/100 Ethernet interface, and additional peripheral ports.



MICROS Keyboard Workstation 4 (KWS4)

The Keyboard Workstation 4 (KWS4) is MICROS' latest hardware client which runs on the Microsoft® Windows® CE.Net 4.2 operating system. Built on the Workstation 4 chassis, the KWS4 offers a cost-effective alternative to the WS4, and is intended as a successor to the original Keyboard Workstation that was released in 1996.



The KWS4 offers a monochrome LCD five-line display and a 108-key keyboard. The KWS4 requires its own client application—it does not support the clients created for the Eclipse or WS4. The KWS4 client is a SAR application. A site is not required to use the SAR features or place the unit in SAR mode, but the functionality is built in.

The KWS4 is targeted for high volume operations and a wide range of environmental conditions. This workstation can easily be integrated into any existing 9700 System.

Mobile MICROS HHT

The *Mobile MICROS™* HHT is MICROS' new portable hand-held POS terminal.

Manufactured by Symbol Technologies™, the *Mobile MICROS* provides the functional support provided by previous MICROS hand-held units, as well as magnetic card reader, scanner, printer, and SIM support.

Additional components include the Symbol Access Point, battery charger and/or cradle, and printer belt.



Epson TM88 Thermal Printer

The **Epson TM88** is used with PC Workstations to print a variety of POS documents, including customer receipts, order receipts (local or remote), reports, “soft” guest checks, validation chits, time clock receipts (chits), credit card receipts, and vouchers.



Epson U200B

The **Epson U200B** is used as a receipt printer for single workstations. Although slower in print speed than the TM88, this printer provides graphics capability and one original/two copies print ability.



Recommended Communications Option

MICROS Network Cluster Controller (NetCC)

The MICROS Network Cluster Controller (NetCC) is an Ethernet-to-serial converter that supports MICROS RS422 devices. It provides the primary means of driving MICROS RS422 devices, such as IDN printers.



The NetCC is connected to the 9700 System LAN, similar to a diskless PCWS. Each NetCC has eight RS422 ports which provides communication between the 9700 server PC and the following types of devices:

- ◆ MICROS PCWS (Eclipse)
- ◆ Workstation 4 (WS4)
- ◆ Keyboard Workstation 4 (KBWS4)
- ◆ MICROS IDN printers (stand-alone slip, stand-alone roll, etc.) and Epson IDN printers (TM-T88, TM-200, and TM-U950) connected in a multi-drop configuration
- ◆ Remote Cluster Controllers (RCCs)—can be used for systems upgraded from 8700 to 9700, and for new 9700 System installations

For details on NetCC configuration, refer to *Configuring NetCCs* in Chapter 2.

System Overview

Recommended Communications Option



2

9700 Software Platform Installation

In This Chapter

This chapter provides the requirements and instructions for setting up your Microsoft® Windows 2000® Server or 2003 Server system and installing the MICROS 9700 Version 3.0 System software.

Installing Windows.....	2-2
Software Licensing.....	2-2
System Security.....	2-3
Post-Windows Setup	2-8
Microsoft® SQL Server™ 2000 (SP3) or Oracle®9i.....	2-11
Installing the 9700 HMS Application	2-19
Installing 9700 V. 3.0 Components on Clients.....	2-46
Starting the 9700 System	2-59
Configuring Network and Local Printing	2-60
Configuring WinStation Client Workstations	2-70
Configuring Workstation 4 (WS4) Clients.....	2-82
Configuring NetCCs.....	2-85
Backing Up the System: MS-SQL Maintenance Plans.....	2-99

Installing Windows

Windows 2000 with Service Pack 4 (or higher) or Windows 2003 Server must be installed prior to installing the 9700 software. Contractual obligations with Microsoft prevent MICROS Systems, Inc. from providing Service Packs on the 9700 Setup CD. As a result, the Service Pack must be downloaded via the Internet from the Microsoft Web site.

For new installations, your server should already be configured with Windows 2000 Server with Service Pack 4 or Windows 2003 Server.

If you are upgrading from a previous version of 9700, you will have to upgrade your server from Windows NT to Windows 2000 with Service Pack 4 or Windows 2003 before installing the latest version of 9700. Refer to the *Migrating From Windows NT to Windows 2000* document (MD0006-011) for these upgrade procedures. This document is available on the 9700 V. 3.0 Companion CD. Just insert the CD into the CD-ROM drive and then navigate to *MICROS\LES\POS\9700\Documentation\migrate.pdf*.

If you are transferring your existing 8700 system or 9700 system to a new PC, make sure the new 9700 V. 3.0 server has been configured properly with Windows 2000 Server with Service Pack 4, or Windows 2003 Server prior to attempting upgrade procedure listed in Chapter 3: Software Maintenance.

Software Licensing

The 9700 software licensing method uses a parallel or USB port hardware key to control feature licensing. To stay current with the changes in server architecture, but also provide a solution for legacy hardware, MICROS also offers a keyless licensing solution, which is suitable for both old and new systems.

Key licensing is transparent to the user, and integrates seamlessly, using a single application to provide support to both the traditional hardware key and keyless licensing. The keyless licensing feature is automatically activated when a hardware key licensing code is not detected. A unique licensing code, generated by using information from the server's motherboard, ensures that the code is unique to each server.

For information on how to obtain keyless licensing, go to <http://www.micros.com/members/operations/keylesslicensing>.

System Security

This section briefly discusses default groups, users, and file permissions, which are created during the 9700 installation. The groups and users created during the 9700 installation will differ, depending on whether your system is configured as a domain controller, member server, or a workgroup.

- ◆ If the installation is on a domain controller, *domain users and groups* are created.
- ◆ If the installation is on either a member server or workgroup, *local users and groups* are created.

Groups and Users/Passwords

On a Domain Controller or Member Server

Group	Includes These Members	User/Password
MICROS_ADMINS	csremote m9700 micros	csremote/EBUTO
MICROS_USERS	csremote m9700 micros	m9700/micros
RMC_Users	Domain Users group	micros/micros
		9700cfg/undisclosed

Warning *Do not remove the RMC_Users group!*

In a Workgroup

Group	Includes These Members
MICROS_ADMINS	csremote m9700 micros
MICROS_USERS	csremote m9700 micros

User/Password
csremote/EBUTO
m9700/micros
micros/micros
9700cfg/undisclosed

Warning *Do not remove the 9700cfg user!*

Verify the Properties for the 9700cfg user. Make sure it is set to "Password never expires".

Note *If additional security is needed, the m9700 and micros user passwords can be changed as needed by the site administrator.*

Passwords are changed through Control Panel | Administrative Tools | Computer Management | Local Users and Groups. To change the csremote password, please contact MICROS Customer Support.

Groups and Members/Passwords

9700 Installed on a Domain Controller

Members/ Passwords	Groups				
	Domain Admins	Domain Users	MICROS_ADMINS	MICROS_USERS	RMC_Users
csremote/EBUTO	X	X	X	X	
m9700/micros	X	X	X	X	
micros/micros		X	X	X	

Group					
Domain Users					X*

9700 Installed on a Member Server

Members/ Passwords	Groups			
	MICROS_ADMINS	MICROS_USERS	Administrators	RMC_Users
csremote/EBUTO	X	X	X	
m9700/micros	X	X	X	
micros/micros		X		
9700cfg/undisclosed	X		X	

Group				
Domain Users				X*

* The Domain Users group is a “subgroup” within the RMC_Users group. Since the csremote, m9700, and micros users are members of the Domain Users group, they are members of the RMC_Users group.

9700 Installed in a Workgroup

Members/Passwords	Groups		
	MICROS_ADMINS	MICROS_USERS	Administrators
csremote/EBUTO	X	X	X
m9700/micros	X	X	X
micros/micros		X	
9700cfg/undisclosed	X		X

Note *You should limit the number of users who have full Windows 2000/2003 privileges. The system administrator can make changes through Control Panel | Administrative Tools | Computer Management | Local Users and Groups.*

File Permissions for Member Server and Workgroup Configurations

File/Directory	Owner	Permissions
Micros	Administrators	Everyone (Full Control)
LES	Administrators	Everyone (Full Control)
Pos	Administrators	Everyone (Full Control)
9700	Administrators	Everyone (Full Control)
Bin	Administrators	Everyone (Full Control)
etc	Administrators	Everyone (Full Control)
pc1	SYSTEM	Administrators (Full Control) Everyone (Read/Execute) SYSTEM (Full Control)
Log	Administrators	Everyone (Full Control)
text	Administrators	Everyone (Full Control)
tftpboot	Administrators	Everyone (Full Control)
xdt3	Administrators	Everyone (Full Control)
Exceptions		
8700d.log	SYSTEM	Administrators (Full Control) Everyone (Read) SYSTEM (Special Access)
8700errlog	SYSTEM	Administrators (Full Control)

Post-Windows Setup

After Windows is installed, there are some additional tasks you may need to complete before you install the 9700 HMS software.

MICROS Operational Resiliency

Installing a new MICROS Operational Resiliency System

MICROS Operational Resiliency ensures continuity of operations if an application server fails, or needs to be brought down for maintenance. If you are preparing to setup MICROS Operational Resiliency, review this section to make sure the database will be set up properly.

***Note** If you are configuring a 9700 database for a MICROS Operational Resiliency site, make sure the PC on which the database is created (e.g., your laptop) is set up as PC1 (the Primary PC) **prior** to programming the database. This ensures that you will start off with all of the appropriate settings to create a MICROS Operational Resiliency database (i.e., add PC2, the backup PC).*

The process of setting up a MICROS Operational Resiliency pair should be performed in this order:

1. Install 9700 HMS on the Primary PC (PC1). Make sure to select **MICROS Operational Resiliency - Primary** in the *System Type* section on the *9700 HMS Setup* screen during the 9700 software installation (see page 2-29 for details).
2. Once 9700 Version 3.0 finishes installing on PC1, Install 9700 HMS on the Backup PC (PC2). Make sure to select **MICROS Operational Resiliency - Secondary** in the *System Type* section on the *9700 HMS Setup* screen during the 9700 software installation (see page 2-29 for details).
3. Once 9700 Version 3.0 has finished installing on PC2, the Device Table needs to be configured to ensure MICROS Operational Resiliency is set up correctly.
4. For each PC, In EMC > System Hardware > Device Table, enter the Client NIC IP address and the Redundancy NIC IP address into the corresponding fields.

Note *The Redundancy NIC is connected by a crossover cable between PC1 and PC2.*

5. Add Cluster Controllers to PC2 exactly as configured on PC1.
6. On PC1, for every device attached to a Cluster Controller, and for journals, select the backup PC and configure CC#s and CC Channels, exactly as configured in the primary PC.
7. At this point, all hardware (workstations and MMHs) need to be manually configured to recognize the backup IP address and backup CC# (if applicable).

Upgrading an EBUTO System to a MICROS Operational Resiliency System

Upgrading an existing EBUTO System to a 9700 V. 3.0 MICROS Operational Resiliency System requires no additional programming to the user, and happens automatically as part of the upgrade to 9700 V. 3.0. To upgrade an EBUTO System to 9700 Version 3.0 MICROS Operational Resiliency, upgrade the primary server first, followed by the backup server.

PostScript Printers

If you intend to use a PostScript printer, skip the printer installation steps in the Windows installation. Install the printer after you've finished installing the 9700 System software, as the software provides specific files to support PostScript printers.

Follow the steps below to install a PostScript printer.

1. Complete all Windows and 9700 installation steps.
2. From the Windows Desktop, select *Start / Settings / Printers*.
3. Double-click the **Add Printer** icon. The *Add Printer Wizard* screen displays.
4. Click **Next**.
5. Select **Local Computer** or **Network printer**, as appropriate for this printer, then click **Next**.

If you selected **Local Computer**:

- ♦ Select the **Automatically detect and install my Plug and Play printer** option.
- ♦ Click **Next**.
- ♦ When the printer is located and installed, click **Yes** to print a test page.
- ♦ Click **Next**.
- ♦ Click **Finish**.

If the test page prints, you have installed your printer correctly. Click **OK**.

If the test page does not print, click **Troubleshoot** to identify the problem.

If you selected **Network printer**:

- ♦ Click **Next** to search for printers on the network.
- ♦ Select the appropriate printer and click **Next**.
- ♦ Choose if you want this print device to be your default printer, then click **Next**.
- ♦ Click **Finish**.

To install other types of printers, refer to your Windows documentation.

Installing the Database Server

Microsoft® SQL Server™ 2000 (SP3) or Oracle®9i

9700 Version 3.0 now supports a choice of industry-standard database engines to replace the proprietary database built by MICROS and used in all previous versions of the software. A site can select either Microsoft® SQL Server™ 2000 (SP3), or Oracle®9i as the database engine. Please install the database server prior to attempting installation of 9700 Version 3.0.

- ◆ For Microsoft® SQL Server™ 2000 see page 2-12
- ◆ For Oracle® 9i see page 2-15

Note *For those sites providing their own instance of Microsoft® SQL Server™ 2000 (SP3 or higher) or Oracle® 9i, proceed to page 2-19, “Installing the 9700 HMS Application”.*

Installing Microsoft® SQL Server™ 2000 (SP3)

1. Close all applications and return to the *Windows Desktop*.
2. On the server you wish to install MS-SQL on, insert the MICROSOFT SQL Server 2000 CD into the PC's CD-ROM drive. The *MICROS SQL Server 2000 Setup* automatically starts.

Note *If the installation does not start automatically, navigate to the CD-ROM drive and double-click **MICROSSQLSERVER.exe**.*

The *InstallShield Wizard for MICROS SQL Server 2000* screen displays, seen below.

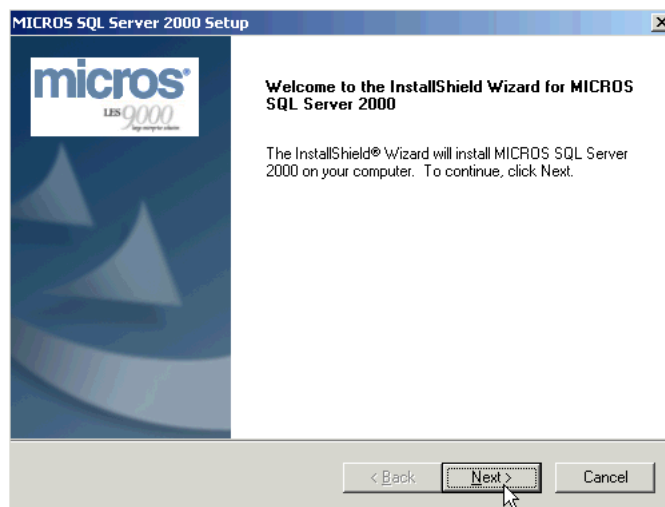

3. After reading the 9700 V. 3.0 System Setup documentation, click **Next** to continue the installation.

4. The *Customer Information* screen displays, seen below. Enter the User Name and Company Name, and click **Next** to continue the installation.

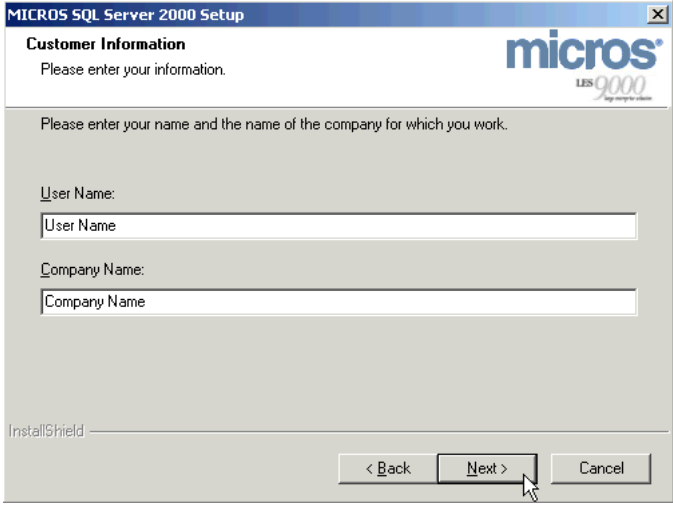

5. The *Choose Destination Location* screen displays, seen below. Choose the default location for the MS-SQL installation, or select **Browse** to choose another location. Once you have decided where you want to install MS-SQL, click **Next** to continue.

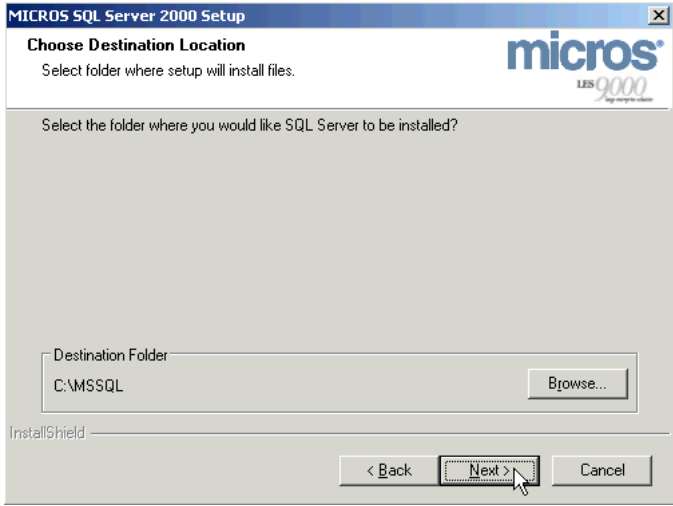

- The *Start Copying Files* screen displays, seen below. This summarizes what will be installed as part of the MICROS MS-SQL Installation. Note that MS-SQL Server 2000 Service Pack 3 is installed automatically. Once you have reviewed this screen, click **Next** to continue.

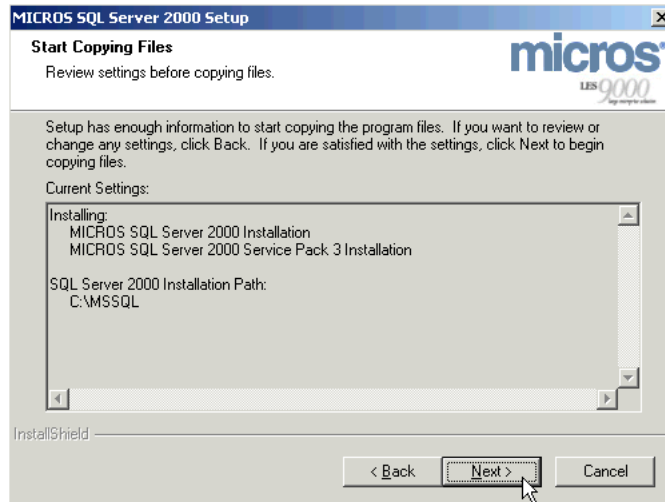

- The installation commences. A series of status messages will display to indicate the progress of the installation.
- After a few minutes, the installation completes. The *InstallShield Wizard Complete* screen displays, seen below, prompting you to restart your computer to complete the installation. Select **Yes, I want to restart my computer now**, then click **Finish** to complete the installation.



- Proceed to page 2-19, Installing The 9700 HMS Application.

Installing Oracle® 9i

1. Close all applications and return to the *Windows Desktop*.
2. On the server you wish to install the database server on, insert the Opera POS database 1 Setup CD into the PC's CD-ROM drive. The *Opera POS database Setup* automatically starts.

Note *If the installation does not start automatically, navigate to the CD-ROM drive and double-click **OperaPOSDatabaseStart.exe**.*

The *InstallShield Wizard for OperaPOS database* screen displays, seen below.

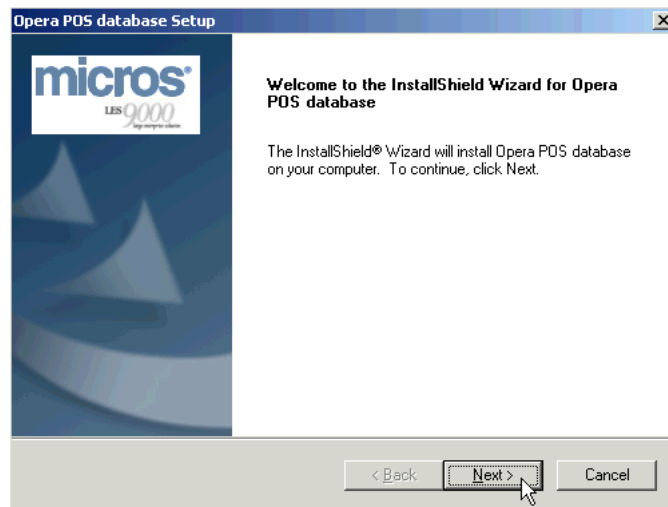

3. After reading the 9700 V. 3.0 System Setup documentation, click **Next** to continue the installation.

- The *Customer Information* screen displays, seen below. Enter the User Name and Company Name, and click **Next** to continue the installation.

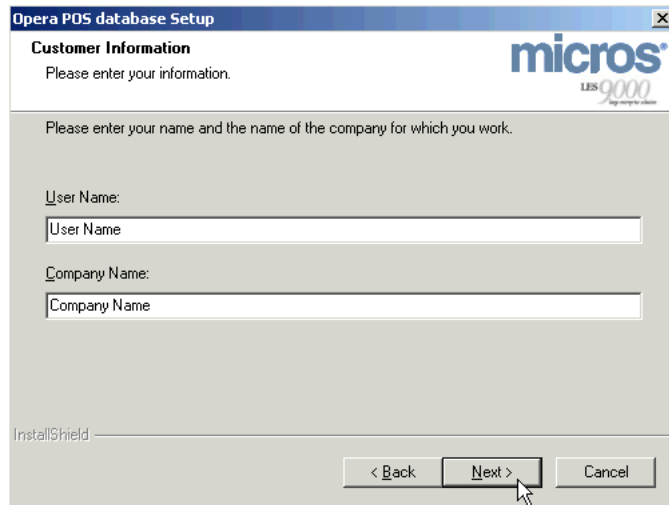

The screenshot shows a window titled "Opera POS database Setup" with a "Customer Information" header. Below the header, it says "Please enter your information." and "Please enter your name and the name of the company for which you work." There are two text input fields: "User Name" and "Company Name". At the bottom right, there are three buttons: "< Back", "Next >", and "Cancel". A mouse cursor is pointing at the "Next >" button. The "micros LIS 9000" logo is in the top right corner.

- The *Choose Destination Location* screen displays, seen below. Choose the default location for the Oracle installation, or select **Browse** to choose another location. Once you have decided where you want to install Oracle, click **Next** to continue.

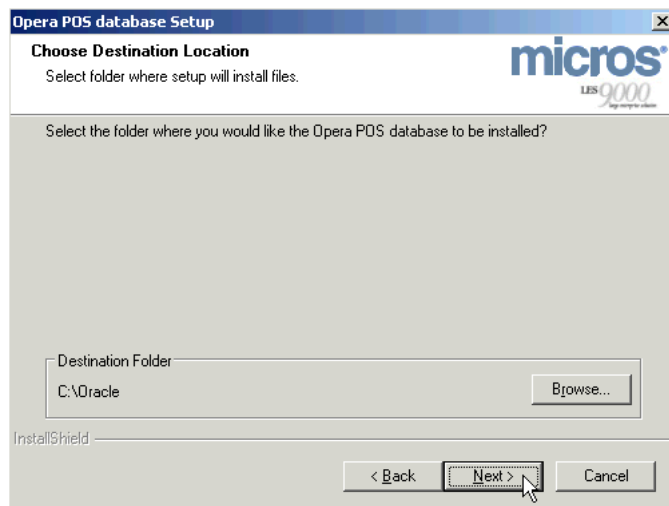

The screenshot shows a window titled "Opera POS database Setup" with a "Choose Destination Location" header. Below the header, it says "Select folder where setup will install files." and "Select the folder where you would like the Opera POS database to be installed?". There is a text input field labeled "Destination Folder" containing "C:\Oracle" and a "Browse..." button to its right. At the bottom right, there are three buttons: "< Back", "Next >", and "Cancel". A mouse cursor is pointing at the "Next >" button. The "micros LIS 9000" logo is in the top right corner.

- The *Start Copying Files* screen displays, seen below. This summarizes what will be installed as part of the MICROS Oracle installation. Once you have reviewed this screen, click **Next** to continue.

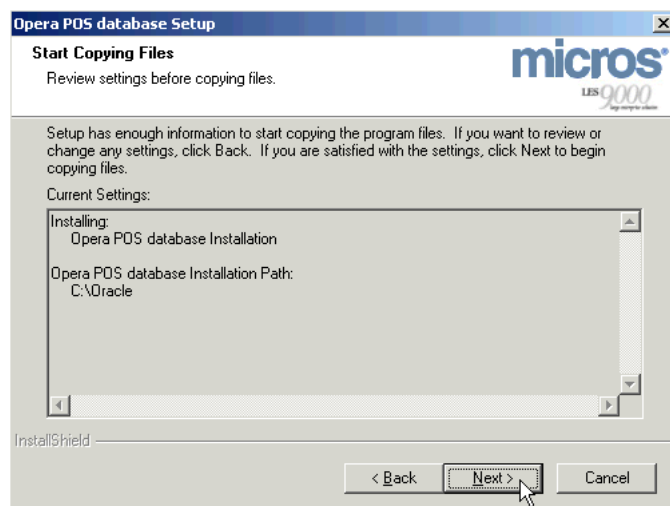

- The installation commences. A series of status messages will display to indicate the progress of the installation. When the installation has finished copying files from the first Installation CD, the *Disk Location* screen displays, seen below. Insert the second Installation CD into the CD-ROM drive, and click **OK** to continue.



- When the installation has finished copying files off the second Installation CD, a second *Disk Location* screen will display, prompting you to insert the third Installation CD into the CD-ROM drive. Once you have inserted the third Installation CD, click **OK** to continue the installation.

9. After a few minutes, the installation completes. The *InstallShield Wizard Complete* screen displays, seen below, prompting you to restart your computer to complete the installation. Select **Yes, I want to restart my computer now**, then click **Finish** to complete the installation.

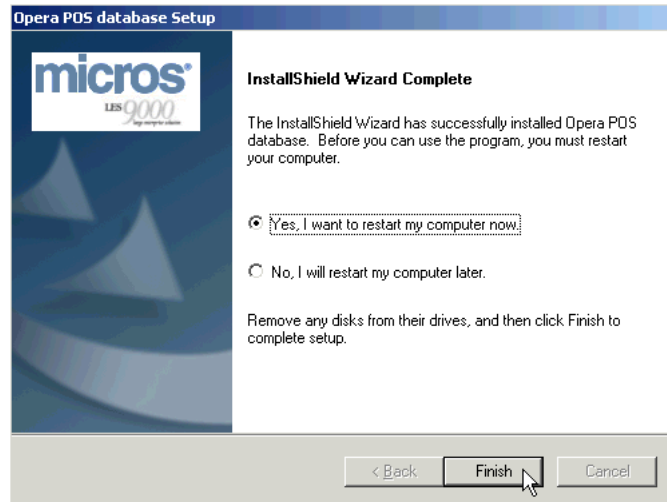

10. Proceed to page 2-19, Installing The 9700 HMS Application.

Installing the 9700 HMS Application

This section will guide you through the steps to install the 9700 System on the server (page 2-20, Installing the 9700 Software on the Server). These instructions pertain to a *first-time installation* of the 9700 System software. If you are upgrading from a previous version of 9700 software, or migrating from an 8700 System to a 9700 System, refer to *Chapter 3—Software Maintenance*.

The instructions in this section assume that you have installed and configured the following elements on the 9700 server:

- ◆ Windows 2000 Server (Service Pack 4 or higher) or Windows 2003 Server
- ◆ Microsoft® SQL Server™ 2000 (Service Pack 3) or Oracle® 9i — this does not need to be installed on the 9700 server, but must be available on the network.
- ◆ Internet Explorer 6.0
- ◆ Internet Information Services (IIS)

Before You Begin

Before installing the 9700 System software, the following should be noted:

- ◆ MICROS strongly recommends a Uninterruptible Power Supply (UPS) be installed on every MICROS 9700 System.
- ◆ Follow the prompts in the 9700 System software installation. If you cancel the installation after it starts, using any method other than through the provided prompts, the results can be unpredictable.
- ◆ The individual installing the software must be logged on as “Administrator” before running 9700 Setup on a Windows system.
- ◆ Make sure that all programs/applications are closed on the PC. If the system detects an active program/process during the installation routine, a notification to close them may display.
- ◆ When configuring 9700 through AutoSequencer, 9700 Remote Management Console, 9700 Enterprise Management Console, or the Cygwin shell prompt, use the *forward slash (/)*, rather than the standard Windows backward slash (\).

Installing the 9700 Software on the Server

Although the 9700 Version 3.0 software for both Microsoft SQL Server and Oracle 9i use the same installation CD, the installation process differs depending on your choice of open database platform. Please consult the appropriate section for installation instructions:

- ◆ For the MS-SQL version of 9700 Version 3.0, please refer to page 2-21.
- ◆ For the OperaPOS (Oracle) version of 9700 Version 3.0, please refer to page 2-34.

Note *These instructions pertain to a **first-time installation** of the 9700 System software. If you are upgrading from a previous version of the 9700 System software, or migrating from an 8700 system to a 9700 system, please refer to Chapter 3—Software Maintenance.*

Installing 9700 Version 3.00 – MS-SQL 2000 (SP3)

1. Close all programs and return to the *Windows Desktop*.
2. Insert the 9700 Version 3.0 CD into the PC's CD-ROM drive. The *9700 HMS* splash screen displays briefly...



...and then the main installation screen, the *Welcome to the InstallShield Wizard for 9700 HMS* screen displays, seen below.

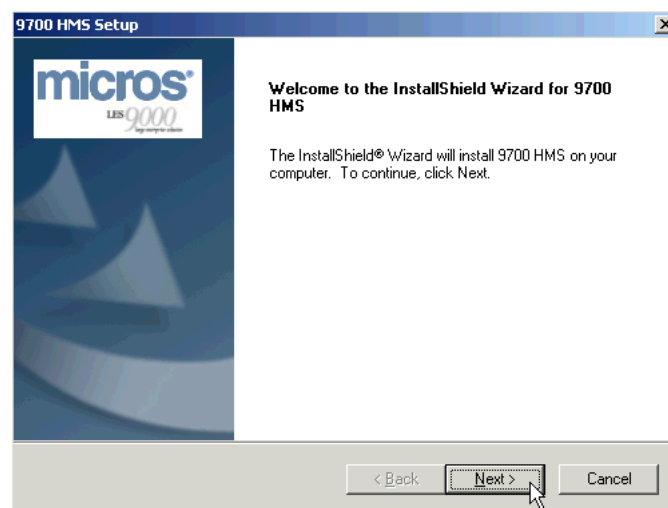

3. After reading the 9700 V 3.0 System Setup documentation, click **Next** to continue the installation.

4. The *Customer Information* screen displays, seen below. Enter the User Name and Company Name, and click **Next** to continue the installation.

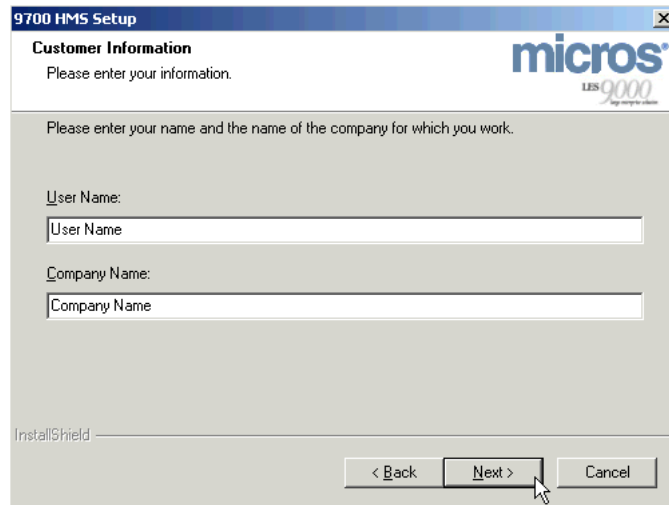

The screenshot shows the '9700 HMS Setup' window with the 'Customer Information' tab selected. The window title is '9700 HMS Setup' and it features the 'micros' logo with 'LES 9000' underneath. The text 'Please enter your information.' is displayed. Below this, it says 'Please enter your name and the name of the company for which you work.' There are two text input fields: 'User Name' and 'Company Name'. At the bottom, there are three buttons: '< Back', 'Next >', and 'Cancel'. The 'Next >' button is highlighted with a mouse cursor. The 'InstallShield' logo is visible in the bottom left corner.

5. The *Component Selection* screen displays. This screen allows a user to configure what elements of the 9700 V. 3.0 software are installed during this installation session. The default selection is to install all elements of the 9700 V. 3.0 software, as seen below.

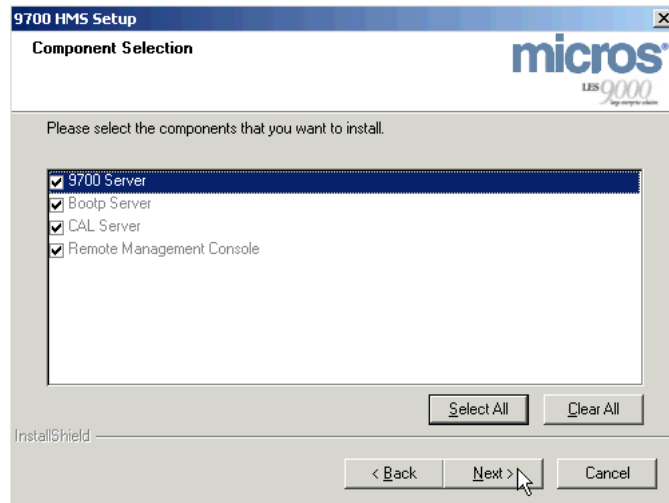

The screenshot shows the '9700 HMS Setup' window with the 'Component Selection' tab selected. The window title is '9700 HMS Setup' and it features the 'micros' logo with 'LES 9000' underneath. The text 'Please select the components that you want to install.' is displayed. Below this, there is a list of components with checkboxes: '9700 Server', 'Bootp Server', 'CAL Server', and 'Remote Management Console'. All checkboxes are checked. At the bottom, there are two buttons: 'Select All' and 'Clear All'. Below these, there are three buttons: '< Back', 'Next >', and 'Cancel'. The 'Next >' button is highlighted with a mouse cursor. The 'InstallShield' logo is visible in the bottom left corner.

Note *Unchecking the “9700 Server” box, allows the user to select which components to install. For instructions on variable installations of 9700 V. 3.0, please refer to “Installing 9700 V. 3.0 Components on Clients” on page 2-46.*

When you have decided which components of the 9700 V. 3.0 software to install, click **Next** to continue.

6. A status message displays, “Setup is searching for Internet Information Services (IIS)”. If you neglected to install IIS, the installation will error out. If IIS is installed, proceed to step 7.
7. The *Installation Drive Selection* screen displays, seen below. Select the drive to install 9700 Version 3.0 on.

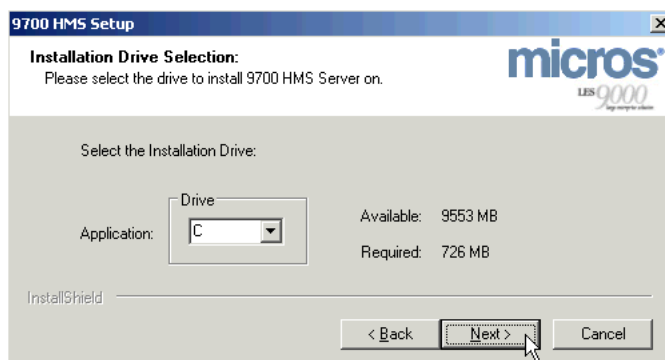

Note *MICROS strongly recommends you do not install 9700 Version 3.0 on the same drive as your Operating System (Windows).*

After you have selected the drive you want to install 9700 V. 3.0 on, click **Next** to continue.

8. The *Select the Database Type* screen displays, seen below.

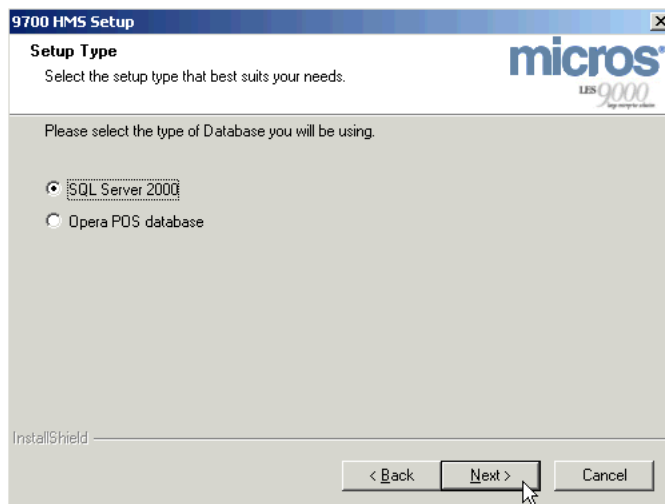

Select **SQL Server 2000**, then click **Next** to continue.

9. The *Database Information* screen displays, (Local Machine configuration shown) seen below. Configure the screen according to the installation parameters detailed below:

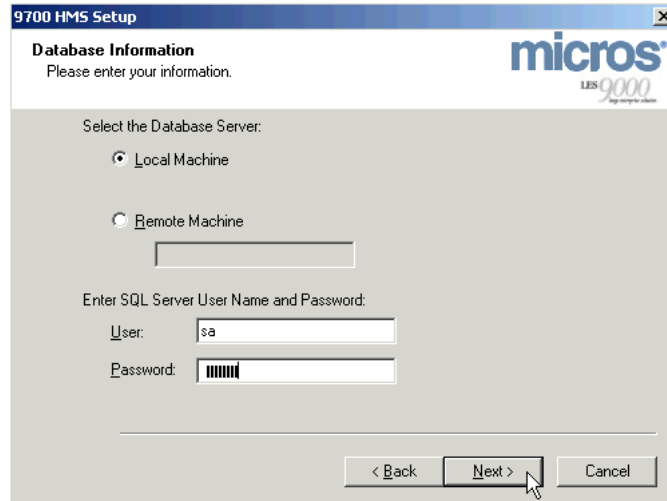

Select the Database Server:

- ♦ **Local Machine** - choose this option if Microsoft SQL Server is located on the server you are installing 9700 Version 3.0 on, i.e., a local installation.
- ♦ **Remote Machine** - choose this option if Microsoft SQL Server is *NOT* located on the server you are installing 9700 Version 3.0 on, i.e., a remote installation off the site's network. Enter the computer name or the static IP address to identify the MS-SQL server on the network.

Enter SQL Server User Name and Password:

- ♦ **User** - MICROS uses the default **sa**. If the site is providing their own instance of Microsoft SQL Server, consult site IT for the MS-SQL User Name.
- ♦ **Password** - MICROS uses the default **mymicros**. If the site is providing their own instance of Microsoft SQL Server, consult site IT for the MS-SQL Password.

Once you have configured this screen accordingly, click **Next** to continue.

10. The *Database Name* screen displays, seen below.

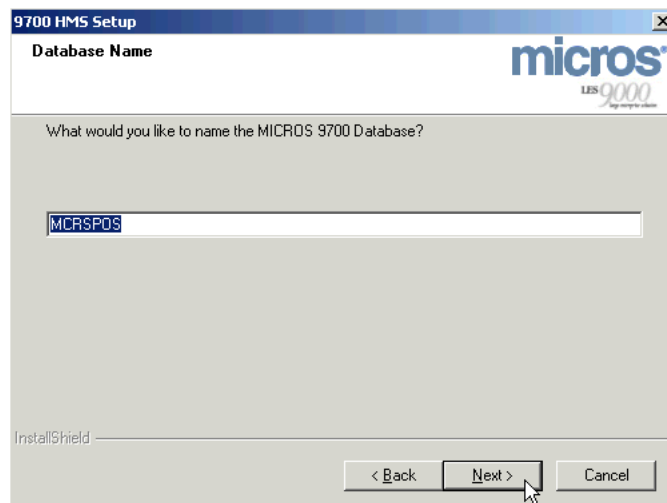
The screenshot shows a window titled "9700 HMS Setup" with a "Database Name" section. The text asks, "What would you like to name the MICROS 9700 Database?". A text input field contains the default name "MCRSPOS". At the bottom, there are three buttons: "< Back", "Next >", and "Cancel". A mouse cursor is pointing at the "Next >" button. The "InstallShield" logo is visible in the bottom left corner.

The default Database Name is **MCRSPOS**. If you wish to change the name, type the new name into the field. Once you have decided the Database Name, click **Next** to continue.

11. The *MICROS Database Owner* screen displays, seen below. Enter the name and password for the User that will own the MICROS MS-SQL database.

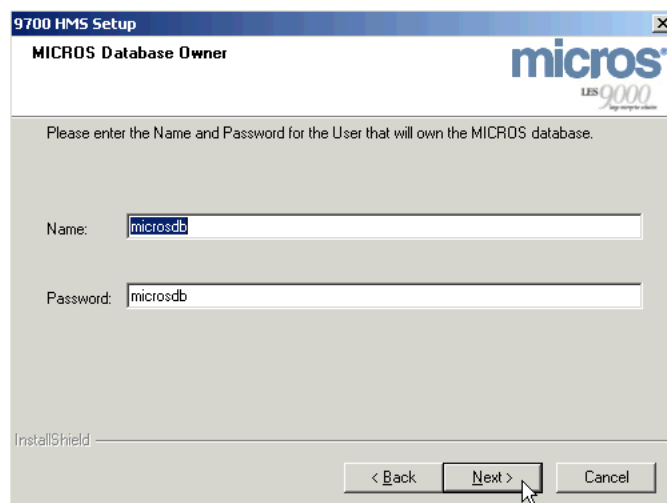
The screenshot shows a window titled "9700 HMS Setup" with a "MICROS Database Owner" section. The text asks, "Please enter the Name and Password for the User that will own the MICROS database.". There are two text input fields: "Name:" with "microsdb" and "Password:" with "microsdb". At the bottom, there are three buttons: "< Back", "Next >", and "Cancel". A mouse cursor is pointing at the "Next >" button. The "InstallShield" logo is visible in the bottom left corner.

The default Database Owner User Name and Password are both **microsdb**. If you wish to change the User Name or Password, change the values now. Once you have decided the Database Owner User Name and Password, click **Next** to continue the installation.

12. The *SQL Server Database File Location* screen displays, seen below. Select the Folder where you would like the SQL Server Database files to be saved.

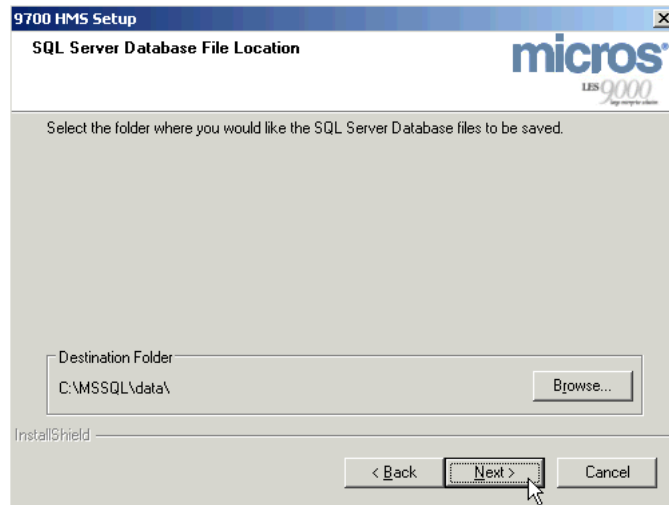

Accept the default location, or click **Browse** to select a different location. Once you have selected the Destination Folder, click **Next** to continue the installation.

13. A *9700 HMS Setup* status message displays, seen below.

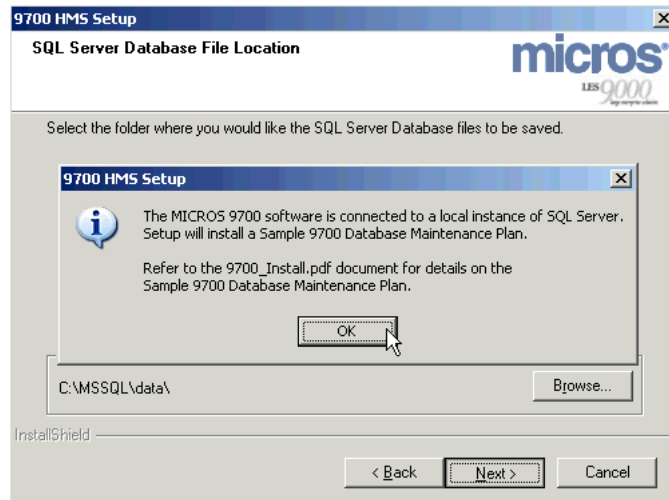

This message informs the user that Setup will install a Sample 9700 Database Maintenance Plan. For details on the Sample 9700 Database Maintenance Plan, refer to page 2-99 “Backing up the System”. After you have read this message, click **Next** to continue.

14. The *Backup Destination Path* screen displays, seen below.

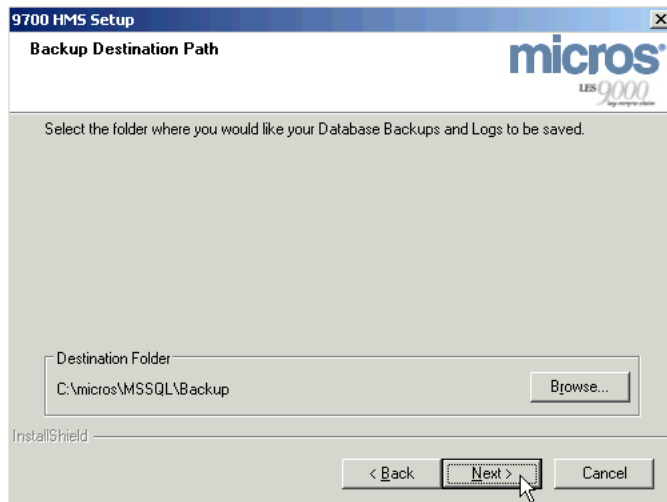

Accept the default location, or click **Browse** to select a different location. Once you have selected the Destination Folder, click **Next** to continue the installation

15. The *9700 HMS Installation Summary* screen displays, seen below.

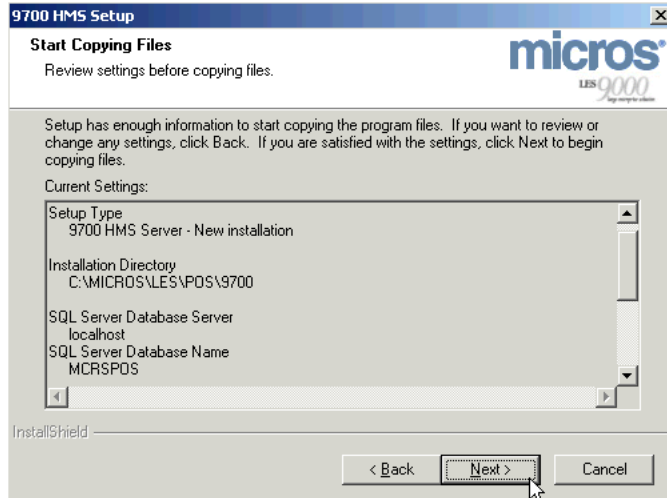

This screen provides a summary of all the parameters defined in the previous steps. Review these settings to make sure these are the correct installation parameters. Once you have verified these settings, click **Next**.

16. The installation commences. Status windows allow the user to monitor the progress of the installation. 9700 Version 3.0 first installs Cygwin, seen below...

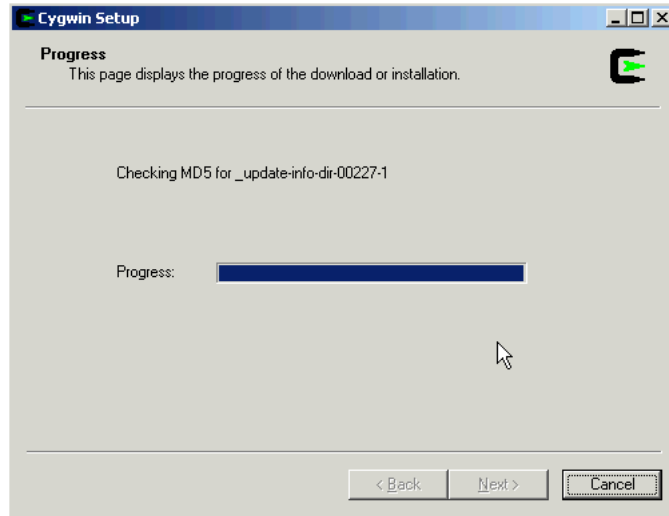

...Once the Cygwin installation completes, 9700 Version 3.0 begins installing the 9700 Server files, seen below...

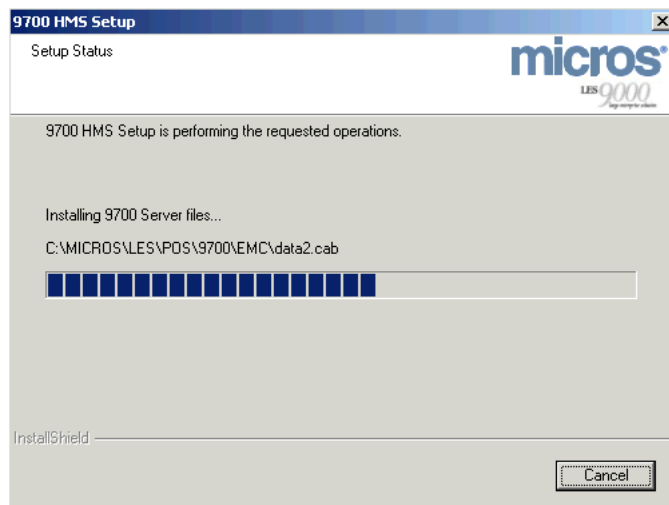

17. After the 9700 Server Files finish installing, the *Select your System Type* screen displays, (Standalone PC configuration shown) seen below.

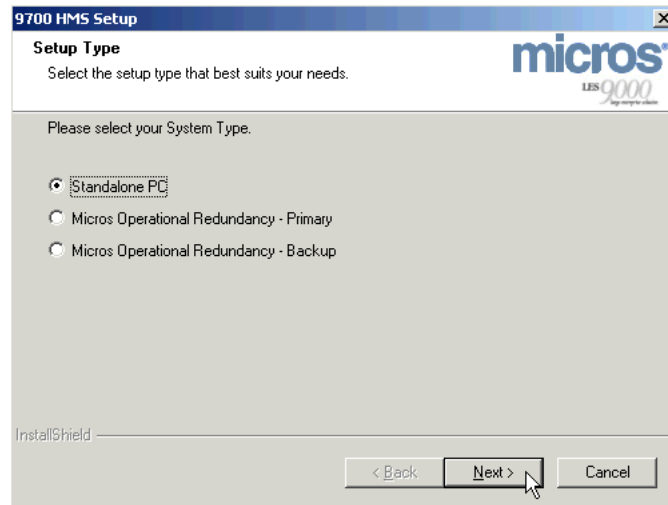

Configure this screen by selecting one of the three options detailed below.

Select your System Type:

- ◆ **Standalone PC -**

Select this option if you are not using a Resilient Backup System.

- ◆ **MICROS Operational Resiliency - Primary**

Select this option if you are using MICROS Operational Resiliency and this is the primary server.

- ◆ **MICROS Operational Resiliency - Backup**

Select this option if you are using MICROS Operational Resiliency and this is the backup server.

Note *If you are installing MICROS Operational Resiliency, do not proceed past this step until you have read the information on page 2-8, “MICROS Operational Resiliency”. This section gives detailed instructions on how to setup and install a MICROS Operational Resiliency System.*

Once you have determined the appropriate Setup Type, click **Next** to continue the installation.

18. The *MICROS 9700 Setup: Diskless Boot Server* screen displays, seen below.

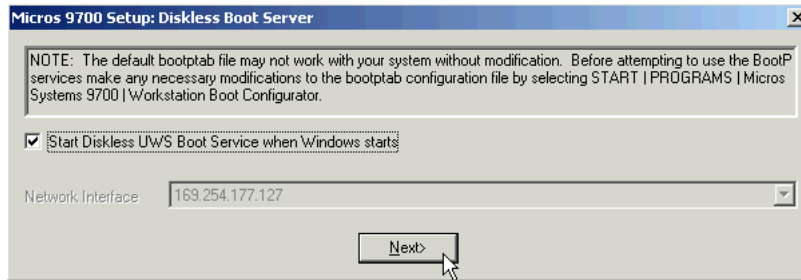

After you have read the NOTE, decide whether you want to **Start Diskless UWS Boot Service when Windows starts**. Click **Next** to continue the installation.

19. The *Setup Type: Make your database selection* screen displays, seen below.

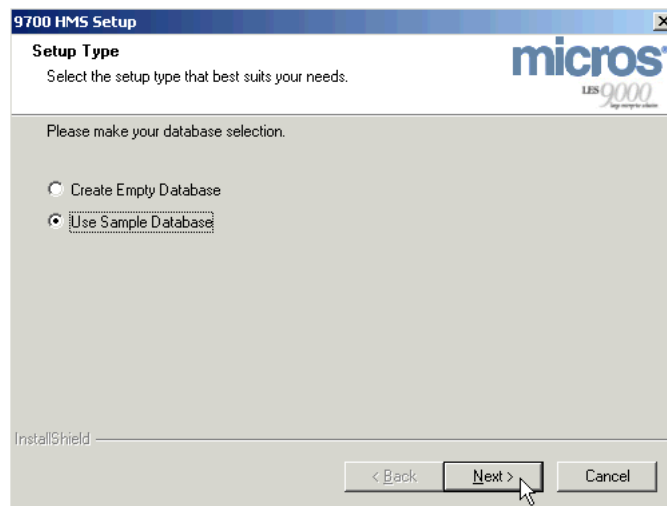

Please make your database selection:

- ◆ **Create Empty Database -**

Select this option if you want to build your 9700 Version 3.0 database from scratch, or if you have an existing database to use as a template. *Upgrade installations must use this configuration.*

- ◆ **Create Sample Database -**

Select this option if you want 9700 HMS Setup to install a Sample Database. This option provides preconfigured templates and options to ease original database programming.

Once you have made your database selection, click **Next** to continue.

20. The installation commences. The *Automatic CAL Service* screen displays, seen below.

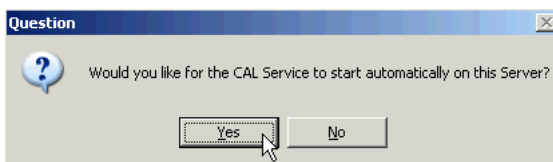

If you would like the CAL Service to start automatically on the server, click **Yes** to continue. If you do not want the CAL Service to start automatically, and instead prefer to manually start the CAL Service, click **No** to continue.

21. A status notification message displays, seen below.

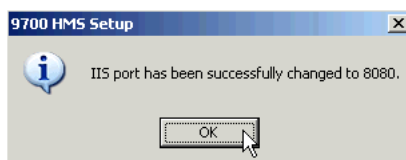

This message notifies the user that the IIS port has been changed to 8080. To continue the installation, click **OK**.

22. A status notification message displays, seen below.

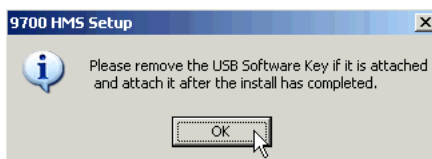

If there is a USB Software Key attached to the server, please remove it from the server now, and attach it after the installation has completed. Once you have removed the USB Software Key, if applicable, click **OK** to continue.

23. A status notification message displays, seen below.

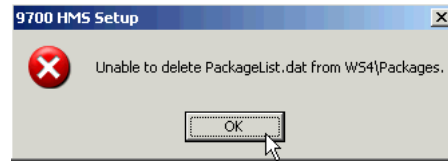

Note *If the WS4\Packages directory does not exist prior to install, you will see this message. 9700 Version 3.0 System Setup is trying to update older versions of the WS4 POS terminal platform. Because this directory only exists on previous 9700 Systems, this message will appear. Please upgrade to the latest Service Pack of 9700 Version 3.0 to obtain the latest WS4 platform updates.*

After reading the Note above, click **OK** to continue the installation.

24. A status notification message displays, seen below.

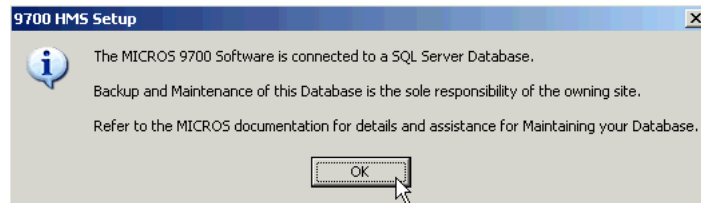

Please refer to page 2-99, “Backing up the System”.

After you have read this section, please click **OK** to continue.

25. The *InstallShield Wizard Complete* screen displays, seen below.

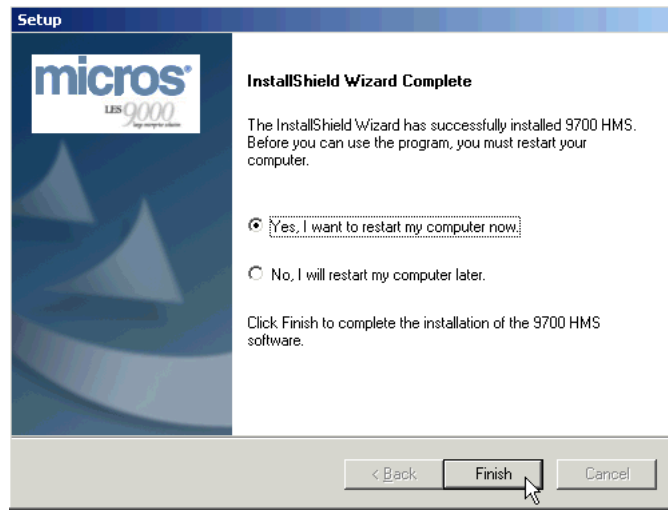

To complete the 9700 Version 3.0 install, select **Yes, I want to restart my computer now.**, then click **Finish**.

Installing 9700 Version 3.0 – OperaPOS

1. Close all programs and return to the *Windows Desktop*.
2. Insert the 9700 Version 3.0 CD into the PC's CD-ROM drive. The *9700 HMS* splash screen displays briefly...



...and then the main installation screen, the *Welcome to the InstallShield Wizard for 9700 HMS* screen displays, seen below.

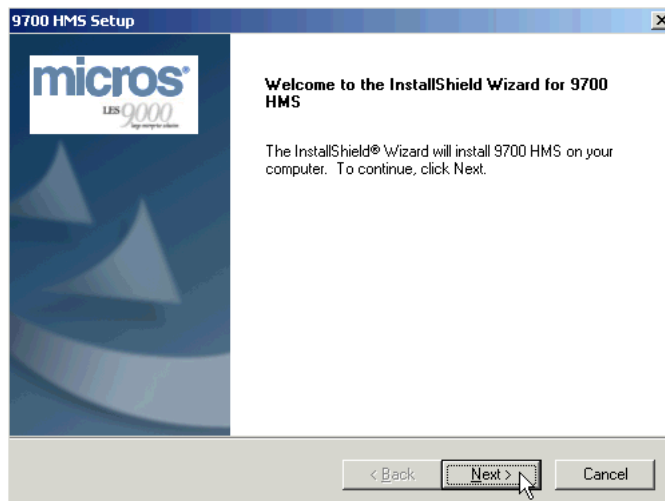

3. After reading the 9700 V. 3.0 System Setup documentation, click **Next** to continue the installation.

- The *Customer Information* screen displays, seen below. Enter the User Name and Company Name, and click **Next** to continue the installation.

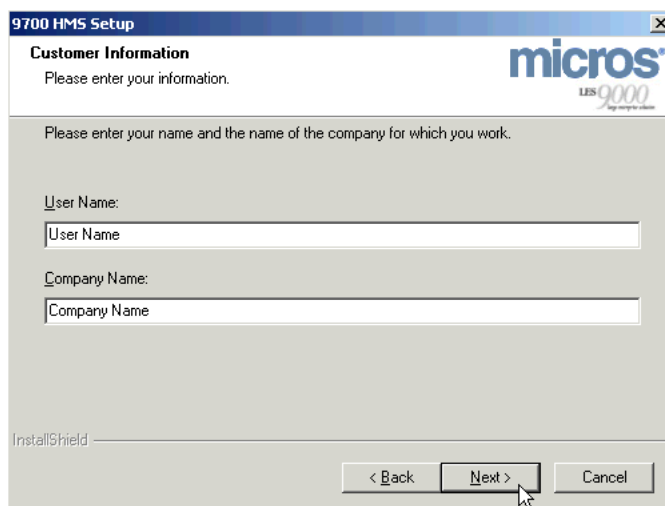

The screenshot shows the '9700 HMS Setup' window with the 'Customer Information' tab selected. The window title is '9700 HMS Setup' and it features the 'micros' logo with 'US 9000' underneath. The text 'Please enter your information.' is displayed. Below this, it says 'Please enter your name and the name of the company for which you work.' There are two text input fields: 'User Name' and 'Company Name'. At the bottom right, there are three buttons: '< Back', 'Next >', and 'Cancel'. A mouse cursor is pointing at the 'Next >' button. The 'InstallShield' logo is visible in the bottom left corner.

- The *Component Selection* screen displays. This screen allows a user to configure what elements of the 9700 V. 3.0 software are installed during this installation session. The default selection is to install all elements of the 9700 V. 3.0 software, as seen below.

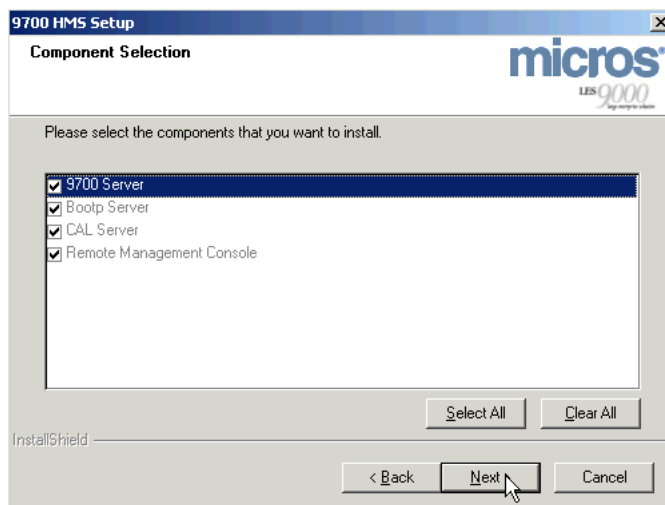

The screenshot shows the '9700 HMS Setup' window with the 'Component Selection' tab selected. The window title is '9700 HMS Setup' and it features the 'micros' logo with 'US 9000' underneath. The text 'Please select the components that you want to install.' is displayed. Below this, there is a list of components with checkboxes: '9700 Server', 'Bootp Server', 'CAL Server', and 'Remote Management Console'. All checkboxes are checked. At the bottom right, there are two buttons: 'Select All' and 'Clear All'. Below these, there are three buttons: '< Back', 'Next >', and 'Cancel'. A mouse cursor is pointing at the 'Next >' button. The 'InstallShield' logo is visible in the bottom left corner.

Note *Unchecking the “9700 Server” box, allows the user to select which components to install. For instructions on variable installations of 9700 V. 3.0, please refer to “Installing 9700 V. 3.0 Components on Clients” on page 2-46*

9700 Software Platform Installation

Installing the 9700 HMS Application

6. A status message displays, “Setup is searching for Internet Information Services (IIS)”. If you neglected to install (IIS), the installation will error out. If (IIS) is installed, proceed to Step 7.
7. The *Installation Drive Selection* screen displays, seen below. Select the drive to install 9700 Version 3.0 on.

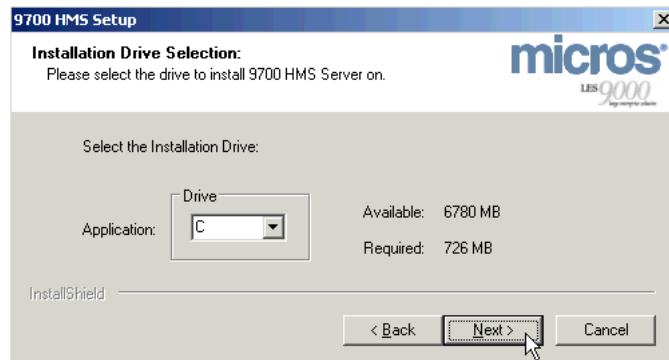

Note *MICROS strongly recommends you do not install 9700 Version 3.0 on the same drive as your Operating System (Windows).*

After you have selected the drive you want to install 9700 V. 3.0 on, click **Next** to continue.

8. The *Select the Database Type* screen displays, seen below.

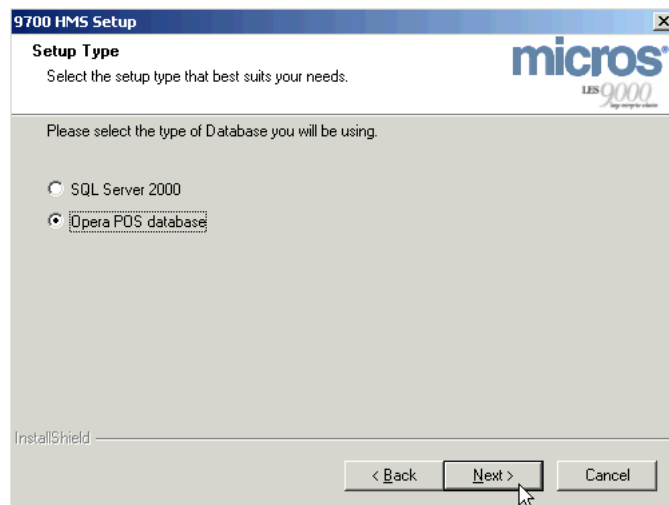

Select **Opera POS database**, then click **Next** to continue.

9. The *OperaPOS database Location* screen displays, seen below

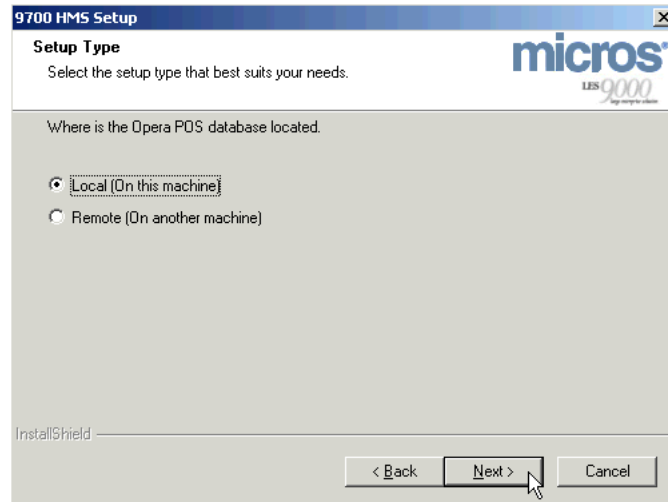

Select the Database Server Location:

- ◆ **Local -** choose this option if you are installing 9700 Version 3.0 using a local instance of Oracle 9i, i.e., Oracle is located on the same server as 9700 V. 3.0.
- ◆ **Remote -** choose this option if Oracle is *NOT* located on the server you are installing 9700 Version 3.0 on, i.e., a remote installation off of the site's network. Enter the computer name or the static IP address when prompted to identify the Oracle server on the network.

Once you have selected the Database Server location, click **Next** to continue the installation.

10. The *Installation Drive Selection* screen displays, seen below.

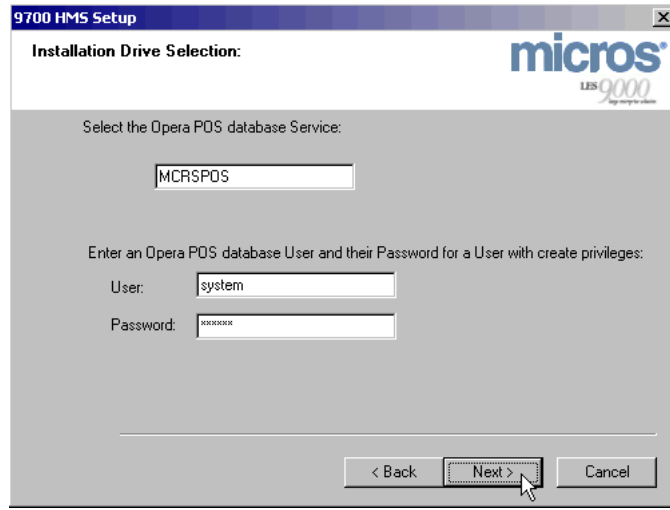

Select the Opera POS Database Service

Enter the Oracle Database Service Name. This is the database service name you wish to store MICROS data on. With a MICROS instance of Oracle this is **MCRSPOS**. Once you have decided the Database Service Name...

Enter Opera POS database User and Password

Enter the User Name and Password for a “user with create privileges”. With a MICROS instance of Oracle this is **system** and **system**. Once you have configured the User Name and Password for a “user with create privileges”, and the Opera POS Database Service, click **Next** to continue.

11. The *Opera POS Database User* screen displays, seen below.

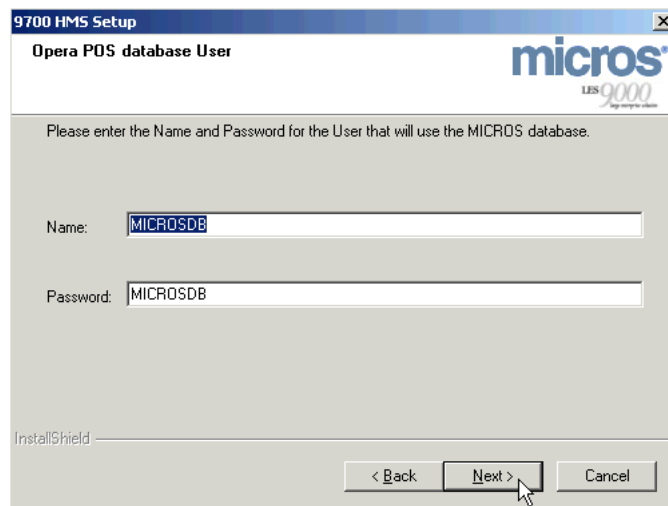

Enter the Name and Password of the User that will use the OperaPOS database. MICROS defaults are **MICROSDB** for both. Once you have entered the Opera POS database User and Password, click **Next** to continue.

12. The *Tablespace Name* screen displays, seen below.

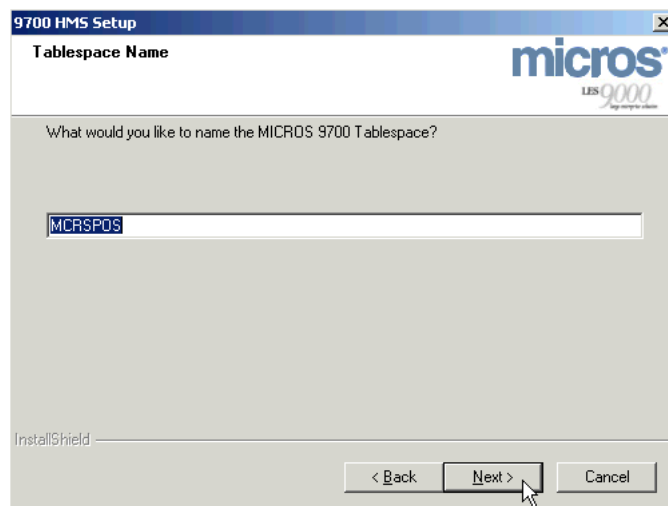

The default MICROS 9700 Tablespace is **MCRSPOS**. If you wish to change the name, type the new name into the field. Once you have decided the Tablespace Name, click **Next** to continue.

13. The *9700 HMS Installation Summary* screen displays, seen below.

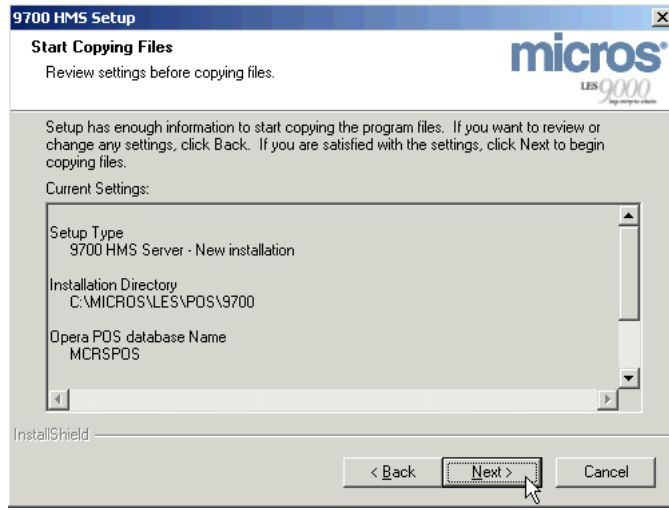

This screen provides a summary of all the parameters defined in the previous steps. Review these settings to make sure these are the correct installation parameters. Once you have verified these settings, click **Next**.

14. The installation commences. Status windows allow the user to monitor the progress of the installation. 9700 Version 3.0 first installs Cygwin, seen below...

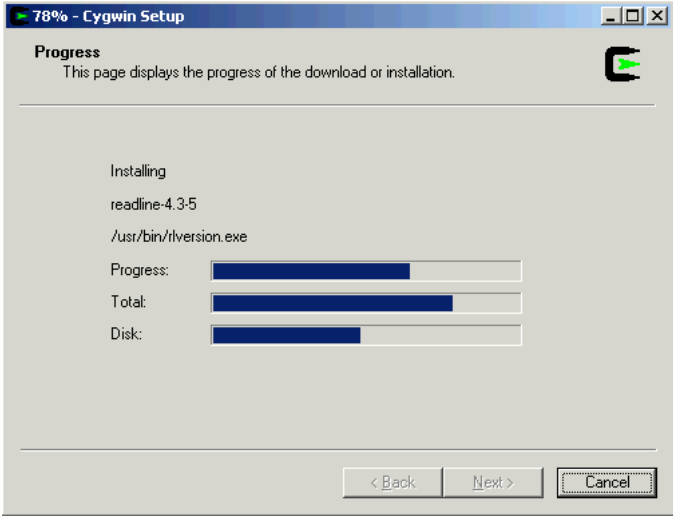

...Once Cygwin installation completes, 9700 HMS Setup begins installing the 9700 Server files.

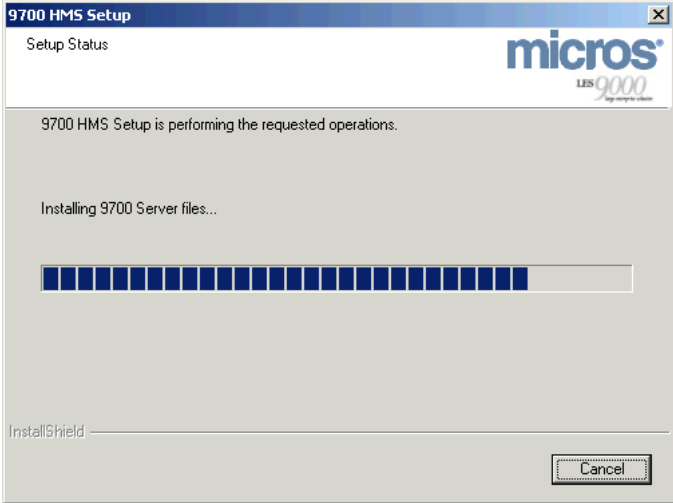

15. After the 9700 Server files finish installing, the *Select your System Type* screen displays, (Standalone PC configuration shown) seen below.

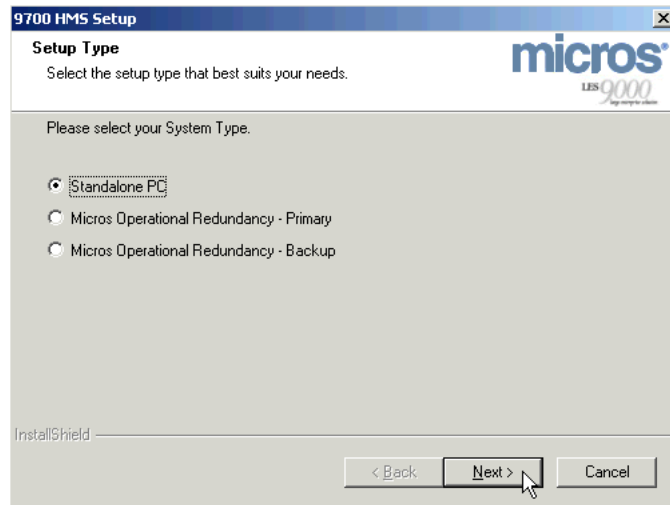

Configure this screen by selecting one of the three options detailed below.

Select your System Type:

◆ **Standalone PC -**

Select this option if you are not using a Resilient Backup System.

◆ **MICROS Operational Resiliency - Primary**

Select this option if you are using MICROS Operational Resiliency and this is the primary server.

◆ **MICROS Operational Resiliency - Backup**

Select this option if you are using MICROS Operational Resiliency and this is the backup server.

Note *If you are installing MICROS Operational Resiliency, do not proceed past this step until you have read the information on page 2-8 “MICROS Operational Resiliency”. This page gives detailed instructions on how to setup and install a MICROS Operational Resiliency System.*

Once you have determined the appropriate Setup Type, click **Next** to continue the installation.

16. The *MICROS 9700 Setup: Diskless Boot Server* screen displays, seen below.

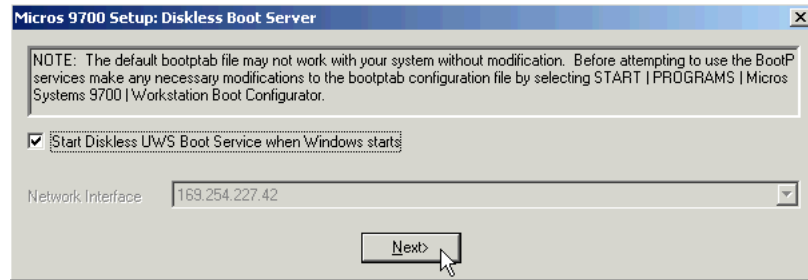

After you have read the NOTE, decide whether you want to **Start Diskless UWS Boot Service when Windows starts**. Click **Next** to continue the installation.

17. The installation commences. The *Automatic CAL Service* screen displays, seen below.

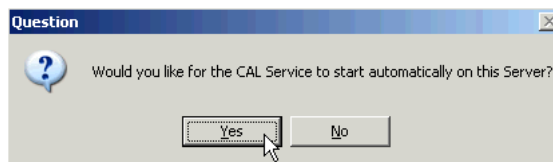

If you would like the CAL Service to start automatically on the server, click **Yes** to continue. If you do not want the CAL Service to start automatically, and instead prefer to manually start the CAL Service, click **No** to continue.

18. A status notification message displays, seen below.

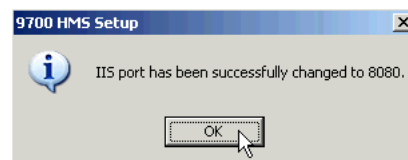

This message notifies the user that the IIS port has been changed to 8080. To continue the installation, click **OK**.

19. A status notification message displays, seen below.

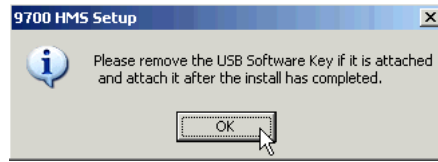

If there is a USB Software Key attached to the server, please remove it from the server now, and attach it after the installation has completed. Once you have removed the USB Software Key, if applicable, click **OK** to continue.

20. A status notification message displays, seen below.

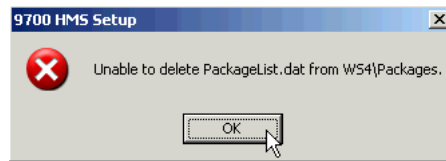

Note *If the WS4\Packages directory does not exist prior to install, you will see this message. 9700 Version 3.0 System Setup is trying to update older versions of the WS4 POS terminal platform. Because this directory only exists on previous 9700 Systems, this message will appear. Please upgrade to the latest Service Pack of 9700 Version 3.0 to obtain the latest WS4 platform updates.*

After reading the Note above, click **OK** to continue the installation.

21. A status notification message displays, seen below.

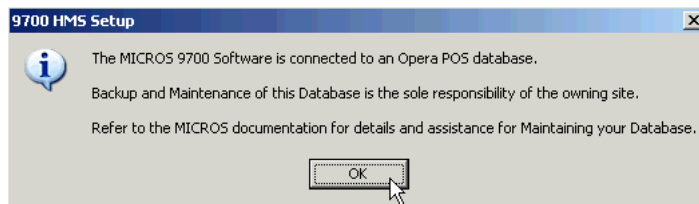

Click **OK** to continue the installation.

22. The *InstallShield Wizard Complete* screen displays, seen below.

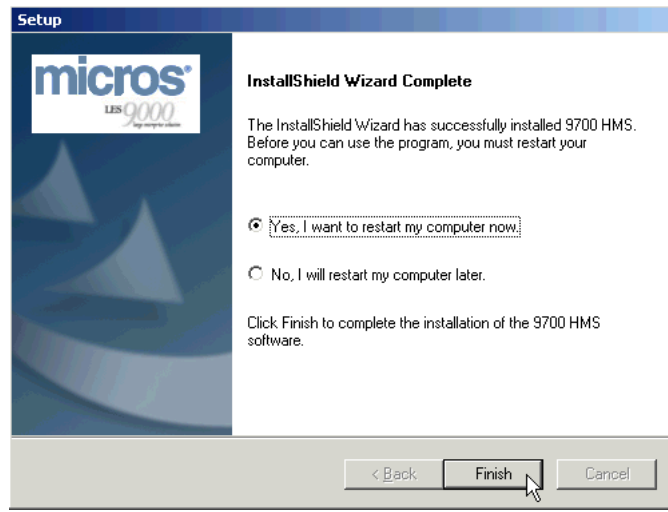

To complete the 9700 Version 3.0 install, select **Yes, I want to restart my computer now.**, then click **Finish**.

Installing 9700 V. 3.0 Components on Clients

Certain components of 9700 HMS Version 3.0 can also be installed on other networked computers. These options allow a site increased database access for ease of programming and system monitoring. While multiple configurations are possible as to what is installed on each networked client, this section is limited to the most common configurations of variable 9700 V. 3.0 installations. For detailed installation instructions, please consult the following pages:

- ◆ Installing Remote Management Console (RMC) p. (2-47)
- ◆ Installing Remote Enterprise Management Console (Remote EMC) p. (2-52)
- ◆ Installing Bootp Service p. (2-54)
- ◆ Installing WinStation p. (2-70)

Installing Remote Management Console (RMC)

Note *Although the 9700 application is only supported on Windows 2000 Server or Server 2003, the Remote Management Console is supported on the following operating systems for the client:*

- Windows 2000
- Windows XP
- Windows Server 2003

Installing the Remote Management Console on a client PC allows the user easy access to the Autosequencer and Reporting modules without having to go the MICROS 9700 V. 3.0 server.

Follow the steps below to install the *Remote Management Console* on the client.

1. Close all programs and return to the Windows Desktop.
2. Insert the 9700 HMS Version 3.0 CD into the PC's CD-ROM drive. The 9700 HMS splash screen displays briefly...



...and then the main installation screen, the *Welcome to the InstallShield Wizard for 9700 HMS* screen displays, seen below.

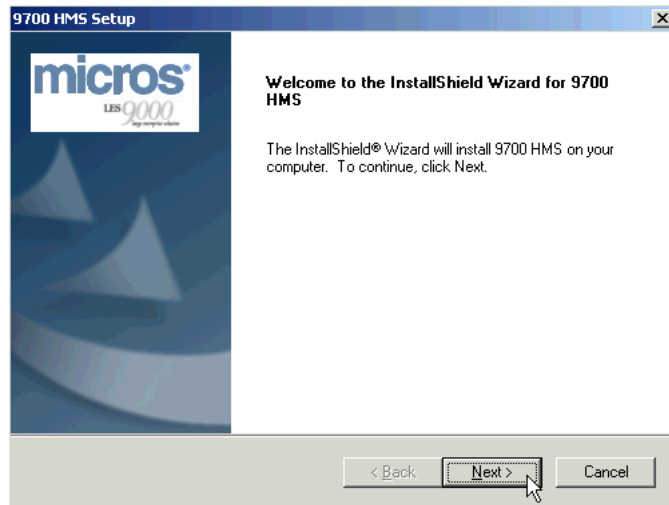

3. After reading the 9700 V. 3.0 System Setup documentation, click **Next** to continue the installation.
4. The *Customer Information* screen displays, seen below. Enter the User Name and Company Name, and click **Next** to continue the installation.

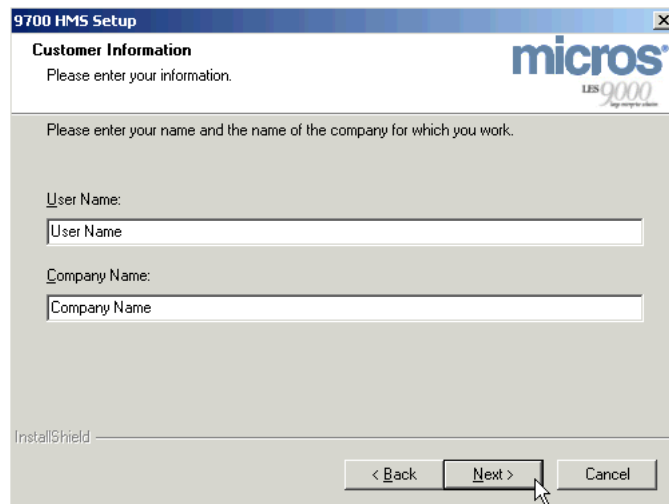

- The *Component Selection* screen displays. This screen allows a user to configure what elements of the 9700 V. 3.0 software are installed during this installation session.

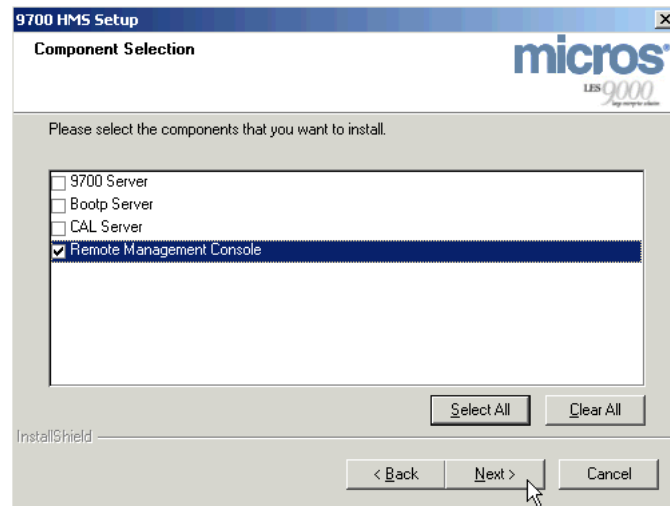

Note *Unchecking the “9700 Server” box, allows the user to select which components to install.*

Select “Remote Management Console”, as seen above, then click **Next** to continue.

- The *Installation Drive Selection* screen displays, seen below. Select the drive to install the Remote Management Console on.

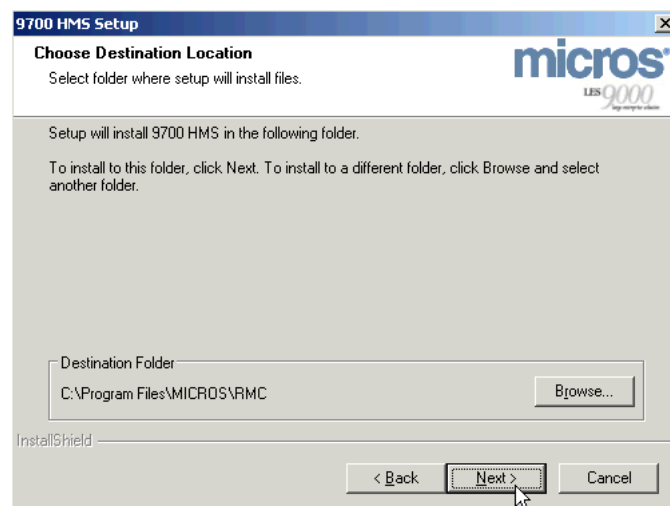

After you have selected the destination folder, click **Next** to continue.

7. The *9700 HMS Installation Summary* screen displays, seen below.

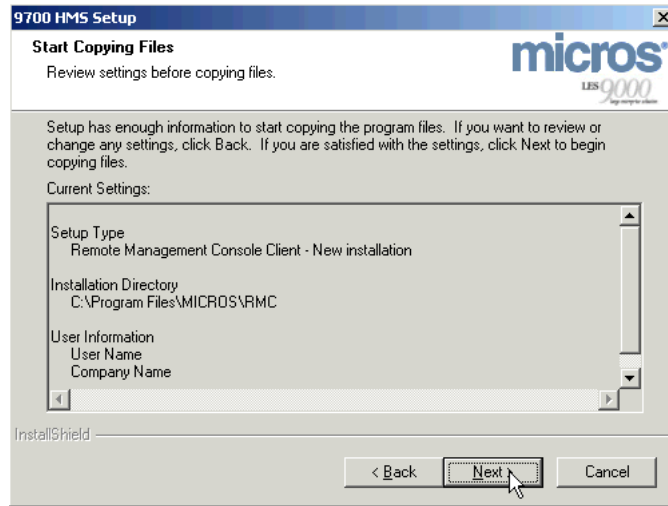

This screen provides a summary of all the parameters defined in the previous steps. Review these settings to make sure these are the correct installation parameters. Once you have verified these settings, click **Next**.

8. The installation commences...

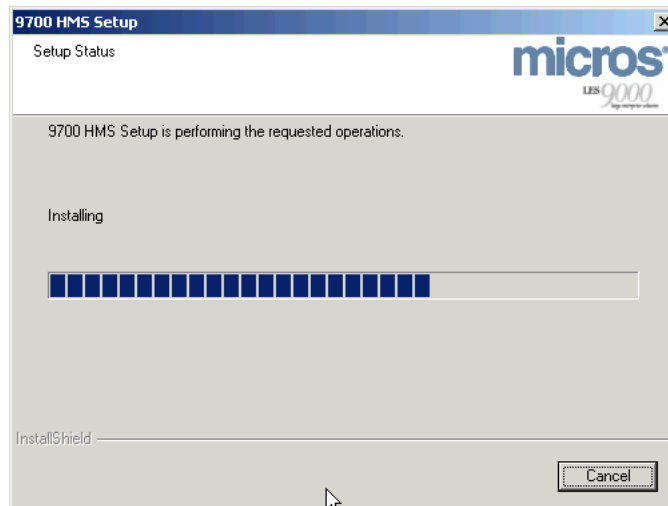

9. After a few moments, the *Database Server Name* screen displays (local configuration shown). This screen prompts for the Computer Name or Static IP address of the database server on the network.

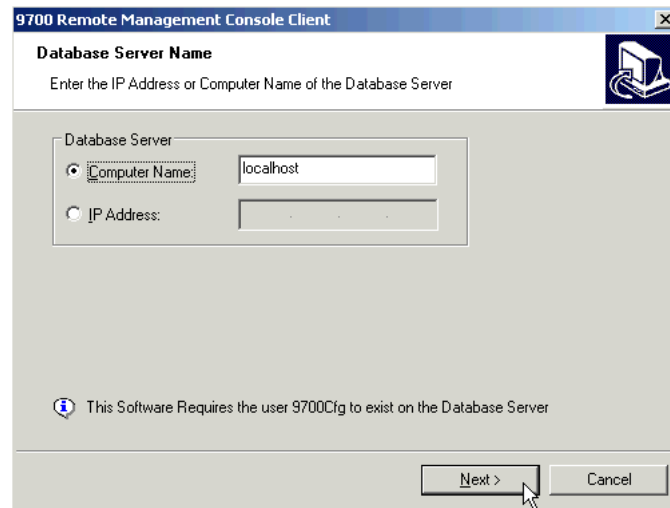

Once you have entered the Computer Name or Static IP address of the database server on the network, click **Next** to continue.

10. After a few moments, the *InstallShield Wizard Complete* screen displays, seen below. To finish the installation select **Yes, I want to restart my computer now.**, then click **Finish**.

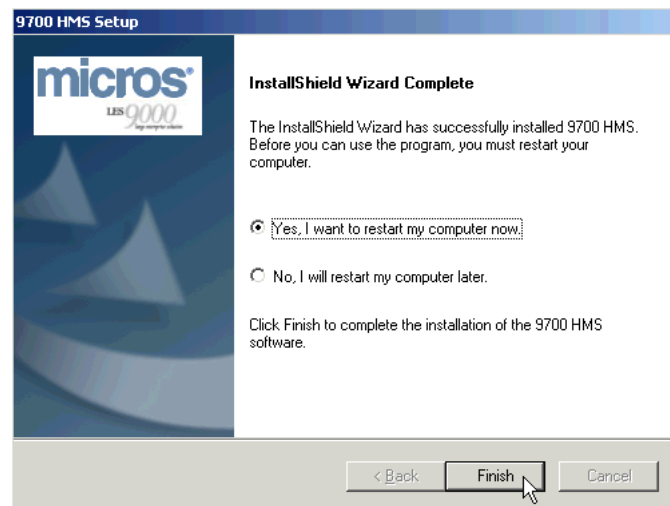

Installing Remote Enterprise Management Console (Remote EMC)

Remote EMC is a fully functional application capable of performing the same tasks as the EMC located on the server PC. You can perform all operations, including use of the Control Panel by using the Remote EMC. This tool allows customers greater flexibility, convenience, and control over their system, because remote EMC users can access the application from an existing web browser (Internet Explorer) on their PC over a network, or even over the Internet.

Installing Remote EMC

After 9700 HMS Version 3.0 has been installed on the MICROS server, from the client PC, access this URL from the Internet Explorer Browser:

<http://servername:8080/emc/>. An InstallShield Screen appears, seen below. Click “Install” to start Remote EMC Installation. Follow the prompts to install.

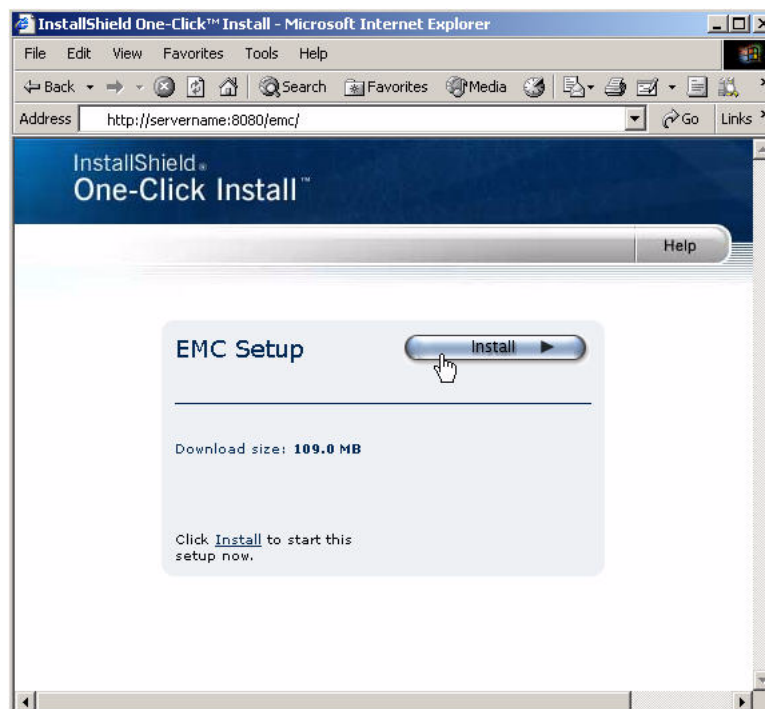

Note For MS-SQL installations, MS-SQL Client files and EMC Client files are installed into the C:\Program Files\MICROS directory. These are about 66 KB in size.

For Oracle installations, those same folders are installed, along with Oracle Client files in the C:\Program Files\Oracle directory. These files are about 78 MB in size.

Using Remote EMC

Once Remote EMC has been installed, you can run Remote EMC from the client PC, by accessing this URL from the Internet Explorer Browser:

`http://servername:8080/emc/emc.exe.`

(A shortcut is installed in your Windows Start menu.)

Note *If a service pack or upgrade is installed, Remote EMC will be automatically updated the next time Remote EMC is used. There is no need to reinstall Remote EMC.*

Note *Report Writer and Autosequencer cannot be accessed from Remote EMC. Reporting for 9700 Version 3.0 is handled by the RMC. The RMC must be installed on any machine requiring these modules. Like 9700 Version 2.x, RMC must be reinstalled per Service Pack, or you can use 9700 Web Reports.*

Note *If you are installing on Windows 2003, you may get the error message "Your security settings prohibit running ActiveX controls on this page. As a result, the page may not display correctly."*

If so, in Internet Explorer, go to Tools>Internet Options>Security, and decrease your Security Level bar to Medium or lower.

Installing Bootp Service

Install the MICROS 9700 Bootp Service if you want this PC to *only* handle booting diskless clients and not other 9700 System functions. You can install the Bootp Service on several PCs, but you should run Bootp on only one PC at any given time.

Follow the steps below to install the *Bootp Service* on the client.

-
- Note**
- 1. All Network Interface Cards (NICs) must be configured prior to the installation of the Bootp Service*
 - 2. Bootp will not function properly on a PC using DHCP (Dynamic Host Configuration Protocol)*
 - 3. Should the image file become corrupt or missing, a Diskless Client Recovery image file is located in \MICROS\LES\POS\9700\ClientInstalls\Diskless Client Recovery.*
-

1. Close all programs and return to the Windows Desktop.
2. Insert the 9700 HMS Version 3.0 CD into the PC's CD-ROM drive. The 9700 HMS splash screen displays briefly...



...and then the main installation screen, the *Welcome to the InstallShield Wizard for 9700 HMS* screen displays, seen below.

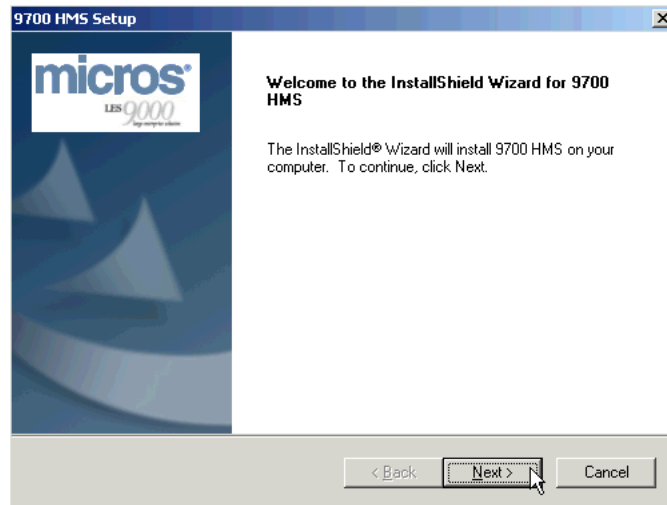

3. After reading the 9700 V. 3.0 System Setup documentation, click **Next** to continue the installation.
4. The *Customer Information* screen displays, seen below. Enter the User Name and Company Name, and click **Next** to continue the installation.

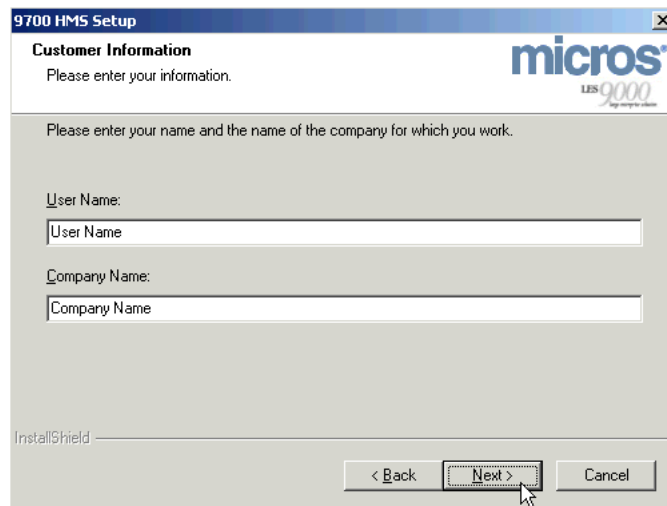

5. The *Component Selection* screen displays. This screen allows a user to configure what elements of the 9700 V. 3.0 software are installed during this installation session.

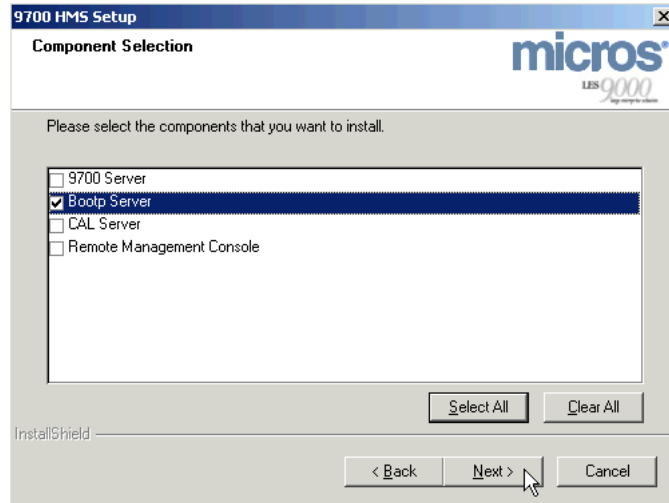

Note *Unchecking the “9700 Server” box, allows the user to select which components to install.*

Select “Bootp Server”, as seen above, then click **Next** to continue.

6. The *Installation Drive Selection* screen displays, seen below. Select the drive to install the Bootp Server on.

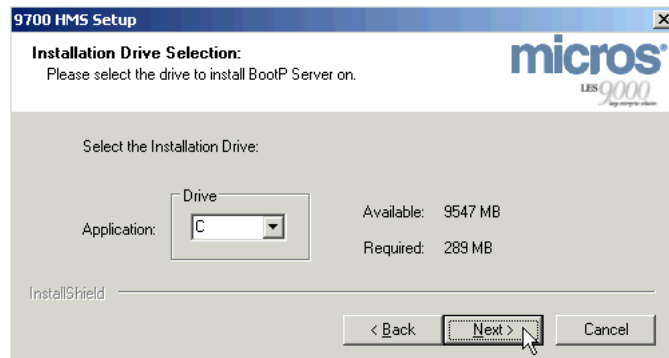

After you have selected the installation drive, click **Next** to continue.

7. The 9700 HMS Installation Summary screen displays, seen below.

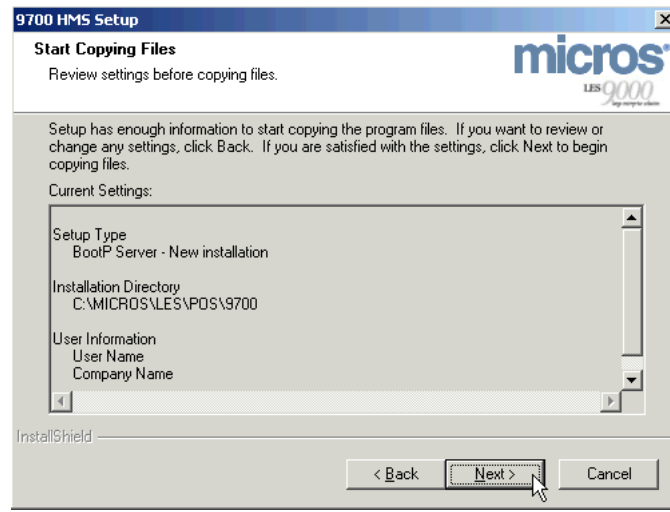

This screen provides a summary of all the parameters defined in the previous steps. Review these settings to make sure these are the correct installation parameters. Once you have verified these settings, click **Next**.

8. The Cygwin installation commences...

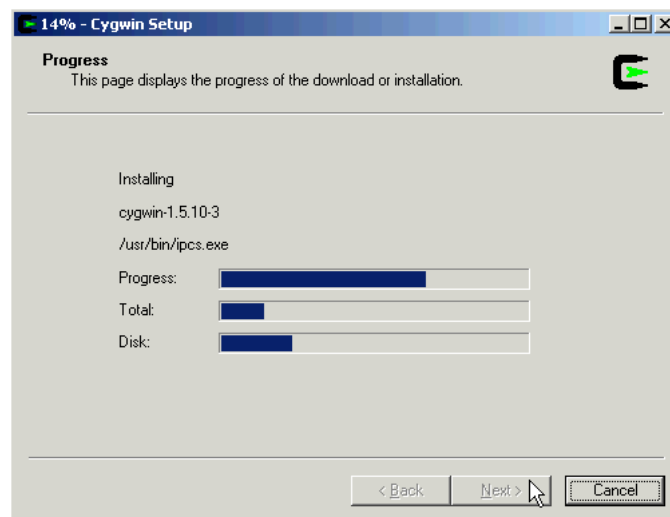

9. After a few moments, the *Diskless Boot Server* screen displays. If you want the MICROS 9700 Bootp Service to automatically start when Windows starts, select the **Start Diskless UWS Boot Service when Windows starts**.

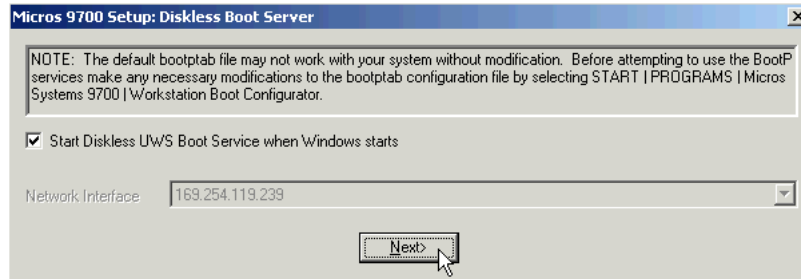

From the **Network Interface** drop down list, choose the NIC that the Bootp Service should use. Once you have configured both of these options, click **Next** to continue.

10. After a few moments, the *InstallShield Wizard Complete* screen displays, seen below.

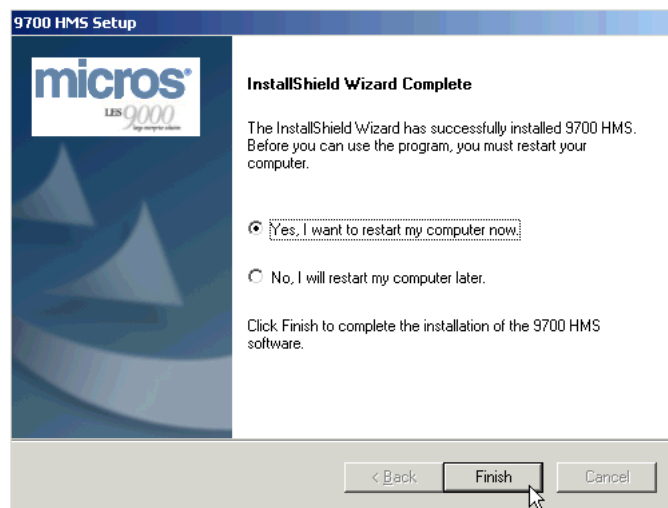

To complete the installation select **Yes, I want to restart my computer now.**, then click **Finish**.

Starting the 9700 System

Once you have installed the 9700 System software and rebooted the server, start the system to ensure the installation was successful.

1. From the Windows Desktop, select *Start / Programs / MICROS Systems 9700 / EMC*.
2. Select the database Server, then click Connect.
3. Enter the username and password, then click Login.
4. If you entered a valid username and password, the EMC opens. Click System|Control Panel on the Left Menu Bar.
5. Click the **Database** button to turn the system ON. The Message window reads: PC1: Starting database. When the 9700 System is successfully loaded on all PCs in the system, the Message window reads: Database started.

Note *Activating the **Database** button allows the user to:*
-Run Autosequences
-Perform 8700sql
-Run a CCBatch
-Run a Check Print

6. Click the **Operations** button to allow workstations to communicate with the 9700 server

Note *If running a MICROS Operational Resiliency pair, the PC Status window changes from "Idle" to "Primary, Live PC#" and "Secondary, Live, PC#".*

Configuring Network and Local Printing

Note *Before you configure network and local printing, make sure your printers are properly added and configured in Windows **first**.*

Anything printed from the *9700 Enterprise Management Console* uses the Windows print settings (refer to page 2-61).

9700 Remote Management Console uses the sample printer files that are installed with the 9700 software (refer to page 2-62). These files will print reports and configuration data in landscape or portrait mode.

Configuring TCP/IP Printing

Although it is highly recommended to have a dedicated Windows Print Server, some sites may not have one on their network. Network printing *can* be accomplished with a standalone printer that has a Network Interface Card (NIC), but every effort should be made to use an alternate Windows Print Server.

All Hewlett-Packard JetDirect cards currently support TCP/IP protocol, and should be added using the standard TCP/IP port. Only older HP-JetDirect cards that do not support TCP/IP require the Hewlett-Packard network port that uses the DLC protocol.



Refer to your Microsoft Windows documentation for information on how to install DLC protocol on the 9700 Server.

Printing in the 9700 Enterprise Management Console (EMC)

The *9700 Enterprise Management Console (EMC)* uses Windows print settings. Most forms can be printed, however, most can only be printed in Table View mode. All Table View printing is set, by default, to print in portrait format.

The **Table View** icon () is disabled if a form is not available in that mode.

Follow the steps below to print a selection in the *9700 Enterprise Management Console*.

1. From the *Windows Desktop*, select *Start / Programs / MICROS Systems 9700 / Enterprise Management Console*.
2. Select the database server, and click *Connect*.
3. Enter the *UserName* and *Password*, then click *Login*.
4. Navigate to the form to print. For example, select: *Personnel / Employees / Maintenance*.
5. Click  .
6. Click  , or select *File / Print* from the *Menu Bar*.
 - ◆ If you choose the *Print* icon, your selection will automatically print.
 - ◆ If you choose the *File / Print* option, a *Print* dialog box displays. Click **OK** to start the print request. The *Print* dialog box also allows you to change the print format (i.e., change *Portrait* to *Landscape*, or vice-versa):
 - ◆ Click the **Properties** button.
 - ◆ Make your selection(s), and click **OK**.
 - ◆ Click **OK** again to start the print request.

Using the Sample Printer Files

Sample printer files are installed when the 9700 System software is installed. These files will print reports and configuration data in landscape or portrait mode from the *9700 Remote Management Console*.

During the software installation, the following sample files are installed:

- ◆ PrintLandscape.txt—prints the report in landscape mode
- ◆ PrintPortrait.txt—prints the report in portrait mode

The type of installation (Server or Remote Management Console Client) will determine the location where these files are installed.

The sample files do require some modification, which is described in *Editing the Sample Printer Files* on page 2-63.

On the Server...

The sample printer files are installed in *X:\Micros\LES\Pos\9700\etc* (where *X:* is the directory where the 9700 System is installed).

You can create an unlimited number of printer configuration files, however, the server only allows up to 16 printer configuration files to be linked in the *Devices* file, which is described on page 2-67.

On the Remote Management Console Client...

The sample printer files are installed in *X:\Program Files\MICROS\RMC\Printers* (where *X:* is the directory where the 9700 Remote Management Console is installed).

You can create an unlimited number of printer configuration files on the client. Unlike the server, these files are *not* linked to any file on the client. Rather, they will all display as selections in the following window when a print command is issued:

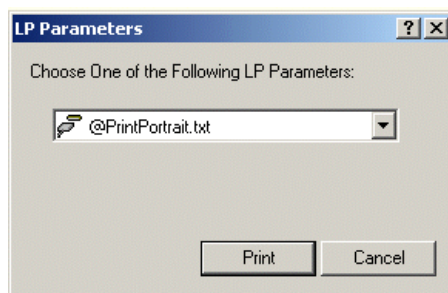

The printer configuration files you create on the client can be identical to those on the server, but it isn't necessary. However, to print from a *specific* client, the printer configuration files must exist on that client.

Note *Printing From Report Writer: All reports in the Report Writer module, with the exception of the **Income Audit** report, use the printer configurations designated in the System Hardware / Device Table on the server.*

*The Income Audit report has its own printer setup strings which must be configured on the **server** in Reporting / Report Configuration / Income Audit / Line Printer Parameters. These printer setup strings can be the same as those programmed in the Device Table, however, they must also be in the Report Configuration file in order for this report to print.*

Editing the Sample Printer Files

Follow the steps below to use the sample printer files at your installation site.

1. Use *Windows Explorer* to navigate to the directory where the sample printer files reside. (This is the *etc* directory if you are at the server, or the *Printers* directory if you are at the Remote Management Console Client, described on page 2-62).
2. Copy and rename the *PrintLandscape.txt* file. **Do not skip this step!**

Warning *In the event that the 9700 software must be reinstalled or upgraded, the *PrintLandscape.txt* file will be overwritten. To avoid overwriting the changes you will make to this file, you must rename the file to preserve its contents.*

*Example: Rename *PrintLandscape.txt* to *Landscape.txt*.*

3. Open the new file using the text editor of your choice. You will see the following line:

```
-d @MicrosDefaultPrinter -lines 66 -cols 150 -land
```

4. Replace @MicrosDefaultPrinter with your printer's name.
 - ◆ Servers and Windows 2000, 2003, or XP Remote Management Console clients require the *full network path and printer name*.

Example: If your printer's network path and name is \\admin\hp4, then you would replace @MicrosDefaultPrinter with \\admin\hp4 and *PrintLandscape.txt* would look like the following:

```
-d \\admin\hp4 -lines 66 -cols 150 -land
```

Note *If a network printer uses spaces in its name, you must add quotes around the printer's name. For example, if the printer's name is \\admin\hp LaserJet 6L, then you would replace @MicrosDefaultPrinter in each sample file with "\\admin\hp LaserJet 6L"*

5. Save and exit the new printer file.
6. Copy and rename the *PrintPortrait.txt* file. **Do not skip this step!**

Warning *In the event that the 9700 software must be reinstalled or upgraded, the *PrintPortrait.txt* file will be overwritten. To avoid overwriting the changes you will make to this file, you must rename the file to preserve its contents.*

*Example: Rename *PrintPortrait.txt* to *Portrait.txt*.*

7. Open the new file using the text editor of your choice. You will see the following line:

```
-d @MicrosDefaultPrinter -lines 90 -cols 150 -port
```

8. Replace @MicrosDefaultPrinter with your printer's name.
 - ◆ Servers and Windows 2000, 2003, or XP Remote Management Console clients require the *full network path and printer name*.

Example: *On servers and Windows 2000, 2003, or XP RMC clients, if your printer's network path and name is \\admin\hp4, then you would replace @MicrosDefaultPrinter with \\admin\hp4 and PrintPortrait.txt would look like the following:*

```
-d \\admin\hp4 -lines 90 -cols 150 -port
```

Note *If a network printer uses spaces in its name, you must add quotes around the printer's name. For example, if the printer's name is \\admin\hp LaserJet 6L, then you would replace @MicrosDefaultPrinter in each sample file with "\\admin\hp LaserJet 6L"*

9. Save and exit the new printer file.

Configuring Multiple Network or Local Printers

If you have multiple printers, copy and rename the *PrintLandscape.txt* and *PrintPortrait.txt* sample printer files provided with the 9700 System as often as needed.

Example

Copy *PrintLandscape.txt* and rename it:

- ♦ *LandscapePrntr1.txt*,
- ♦ *LandscapePrntr2.txt*,
- ♦ *LandscapePrntr3.txt*, and so on.

Copy *PrintPortrait.txt* and rename it:

- ♦ *PortraitPrntr1.txt*,
- ♦ *PortraitPrntr2.txt*,
- ♦ *PortraitPrntr3.txt*, and so on.

If you are using two network printers, for example, and you want to make Portrait your default style on `\\admin\hp4`, then edit your printer files as described below:

- ♦ `\\admin\hp4` (Network Printer 1), and
- ♦ `\\accounting\hp610` (Network Printer 2)

Edit this file:	To look like this:
PortraitPrntr1.txt (default)	<code>-d \\admin\hp4 -lines 90 -cols 150 -port</code>
PortraitPrntr2.txt	<code>-d \\accounting\hp610 -lines 90 -cols 150 -port</code>
LandscapePrntr1.txt	<code>-d \\admin\hp4 -lines 66 -cols 150 -land</code>
LandscapePrntr2.txt	<code>-d \\accounting\hp610 -lines 66 -cols 150 -land</code>

Configuring Each PC in the Device Table for Multiple Network or Local Printers

Follow the steps below to configure each PC with multiple printers:

1. From the Windows Desktop, select *Start / Programs / MICROS Systems 9700 / Enterprise Management Console*.
2. Select the database Server, and click **Connect**.
3. Enter the **UserName** and **Password**, and click **Login**.
4. Once the **Control Panel** has been started, select *System Hardware / Device Table*.
5. Select a PC from the *Devices* tree.
6. On the *Printer Settings* form, click in the **Line Printer Parameter #1** field and type @PortraitPrntr1.txt
7. Click in the **Line Printer Parameter #2** field and type @PortraitPrntr2.txt
8. Click in the **Line Printer Parameter #3** field and type @LandscapePrntr1.txt
9. Click in the **Line Printer Parameter #4** field and type @LandscapePrntr2.txt

The printer settings should look like the following:

The screenshot shows a dialog box with two tabs: 'General' and 'Printer Settings'. The 'Printer Settings' tab is active. It contains two columns: 'Rpt Printer Setup String' and 'Line Printer Parameter'. There are eight rows, labeled #1 through #8. Row #1 has a blank 'Rpt Printer Setup String' field and '@PortraitPrntr1.txt' in the 'Line Printer Parameter' field. Row #2 has a blank 'Rpt Printer Setup String' field and '@PortraitPrntr2.txt' in the 'Line Printer Parameter' field. Row #3 has a blank 'Rpt Printer Setup String' field and '@LandscapePrntr1.txt' in the 'Line Printer Parameter' field. Row #4 has a blank 'Rpt Printer Setup String' field and '@LandscapePrntr2.txt' in the 'Line Printer Parameter' field. Rows #5 through #8 have blank 'Rpt Printer Setup String' and 'Line Printer Parameter' fields.

	Rpt Printer Setup String	Line Printer Parameter
#1:	<input type="text"/>	@PortraitPrntr1.txt
#2:	<input type="text"/>	@PortraitPrntr2.txt
#3:	<input type="text"/>	@LandscapePrntr1.txt
#4:	<input type="text"/>	@LandscapePrntr2.txt
#5:	<input type="text"/>	<input type="text"/>
#6:	<input type="text"/>	<input type="text"/>
#7:	<input type="text"/>	<input type="text"/>
#8:	<input type="text"/>	<input type="text"/>

10. Fill in the **Line Printer Parameter #5** through **Line Printer Parameter #16** fields, as needed.
11. Repeat Steps 3 through 9 for each PC in the *Devices* tree.
12. Save and exit the *Device Table*.

Testing Printing Options

Follow the example below to test if you've configured the printers correctly:

1. From the Windows Desktop, select *Start / Programs / MICROS Systems 9700 / Remote Management Console*.
2. Log in and click **OK**.
3. Select *Utilities / Reporting / Report Writer*.
4. Select *Financial / System*.
5. Click **Create Report**. The selected report displays.
6. Select *File / Print*.
7. Choose one of the LP Parameters (e.g., *PrintPortrait1.txt*).
8. Click **OK** to start the print request.

Your *System Financial Report* should print in the selected format.

Cancelling a Print Job

Follow the steps below to cancel a print job by using the Windows Print Manager.

1. From the Windows Desktop, select *Start / Settings / Printers*.
2. Select the printer where you want to cancel a print job using one of the following methods:
 - ◆ Double-click the printer's icon.
 - ◆ Right-click on the printer's icon and select **Open**.
 - ◆ Left-click on the printer's icon and select *File / Open* from the *Menu Bar*.
 - ◆ Right-click on the printer icon in the system tray (in the lower right-hand corner) and open the active printer.
3. Highlight the print job to cancel, and either right-click the job's name then select **Cancel**, or choose *Document / Cancel* from the Printer dialog's menu.

Note *You cannot cancel print jobs submitted by other users unless you have Full Control access permissions. Members of the Administrators, Server Operators, or Print Operators group have Full Control by default.*

Configuring WinStation Client Workstations

The WinStation Client application is a Windows 2000 version of the MICROS PCWS application. This application allows you to integrate Windows 2000 Client workstations with your current DOS-based workstations in your 9700 System, which will provide you with multitasking ability on these workstations. Multitasking can allow you to simultaneously run the:

- ◆ 9700 System application
- ◆ Internet
- ◆ Property Management System (PMS)
- ◆ Other applications that you need to access regularly for your business

Any site, regardless of size, which desires or requires the capability to run Windows-based applications on their workstations, would benefit from our WinStation Client application. The ability to minimize one application to access another increases the functionality of the workstation without compromising speed of service.

The WinStation Client application upgrades a workstation from 16-to-32-bit status, which allows this application to take full advantage of the features and functionality of the MICROS 9700 software under a Windows 2000 environment.

The 9700 System can support a combination of DOS and WinStation clients. A WinStation Client can display the standard 12-color DOS icons (.px extension), as well as 256-color Windows icons (.ico extension). The 9700 Server maintains both touchscreen icon sets (see page 2-76 for more information on touchscreen icons).

Benefits of WinStation

- ◆ No additional training is required to use it. From an end user's perspective, this new 32-bit application functions exactly the same way as the 16-bit version. If you're already familiar with the 9700 System, you will see no difference in the way it works.
- ◆ The WinStation Client application increases the functionality of the workstation by allowing other applications not only to reside on the clients, but to be run simultaneously with the 9700 application. This affords the user access to all of the multitasking capabilities, functionality, and high performance of 32-bit programs running under Windows 2000.

For example, a golf resort pro shop could assist a guest who requests a tee time by simply minimizing the MICROS 9700 application (which is used to ring retail and greens fee transactions) and accessing the tee time scheduler.

- ◆ You can integrate the WinStation Client application into your existing 9700 System, and it will coexist with your DOS clients. A comparison of peripheral support between the DOS Client and the WinStation Client application is shown in the table on page 2-72.
- ◆ This application has desktop security features you can enable so that users can access the Windows Desktop on a WinStation Client only if they are privileged to do so. Employee Class Supervisory Privileges and associated keycodes must be enabled to minimize the 9700 application window and access the Windows Desktop. Refer to page 2-74 for more information.

Software and Hardware Requirements

- ◆ Windows 2000 Server with Service Pack 4 or higher, or Server 2003.
- ◆ Internet Explorer 6.0 or higher
- ◆ Workstation 4 or Eclipse PCWS, with a minimum of 64M RAM.
- ◆ MICROS 9700 application Version 1.50 or higher (Server and Clients)

DOS Client vs. WinStation Client Peripheral Support

Device	DOS Client	WinStation Client
Cash Drawer (standard DIN connection)	Y	Y
TCP/IP Connectivity	Y	Y
LCC Connectivity	Y	N
Integrated Mag Card Reader	Y	Y
External MCR (RS232)	Y	Y
External (keyboard)	Y	Y
Internal Rear Display	Y	Y
External Pole Display	Y	Y
Scanner (RS232)	Y	Y
Scanner (keyboard)	Y	Y
Specta Physics Scanner (V1.04 only)	Y	N
Scale	Y	Y
Coin Dispenser (RS232)	Y	Y
NA LDS (RS232)	Y	Y
Host Communications	Y	Y
PMS Interface	Y	Y
Touchscreen	Y	Y
Mouse	Y	Y
WMF Keylock	Y	Y
Standard (PMS Interface)	Y	Y
MAAS	N	Y
S&B Chipcoin	N	Y
CKD	Y	N
Krone	Y	N
Krone Germany	N	Y
Local VSS	Y	Y

Device	DOS Client	WinStation Client
Printers (IDN)		
Epson 290 Slip	Y	Y
Epson 290II Slip	Y	Y
Thermal Printer	Y	N
TMT80	Y	N
TMT88	Y	Y
Ithaca Printer (roll)	Y	N
Ithaca Printer (validation)	Y	N
TM300 (Japanese only)	Y	N
Epson TM300 Fiscal	Y	Y
Bematech (MD20) Fiscal	Y	N
Printers (RS232)		
None		
Printers (parallel)		
Epson TMT88	Y	Y
Laser Printer	Y	Y
Line Printer	Y	Y
Diagnostics		
Touchscreen Macro	Y	N

WinStation Client Security

The WinStation Client application security is implemented in two layers:

- ♦ The first layer of security is the Windows login used during Windows 2000/2003 startup.

This login (currently *micros:micros*) restricts the functions available on the Desktop and in Task Manager. The Desktop does not include the **My Network Places** icon. The table below identifies which options are enabled when a user signs in and then presses **Ctrl+Alt+Del** to access Task Manager.

Button	Is this option enabled?
Lock Workstation	No
Logoff	Yes
Shut Down	Yes
Change Password	No
Task Manager	No
Cancel	Yes

The Autologon procedure is automatically disabled by the WinStationStart.exe program if a user other than *micros:micros* logs on.

- ♦ The second layer of security is based on the WinStation Client application and the MICROS 9700 user login. This layer of security prevents anyone from switching from the WinStation application to another application without being logged in.

By default, the WinStation Client application blocks the user from the use of certain shortcut keys which are used to switch or close applications. The table below identifies which shortcut keys are enabled when a user signs in.

Shortcut Keys	Is this shortcut enabled?
Ctrl+Esc to display the <i>Start</i> menu	No
Ctrl+F4 / ALT+F4 to close the application	No
Windows icon key to display the <i>Start</i> menu (may or may not be included on your keyboard)	No
Alt+Tab to switch between programs	Yes

Fields, Security Options, and Function Buttons

Add a WinStation Client to the *Devices* file, just like any other PCWS. The only difference is that a different **Sub Type** is assigned to the WinStation. The following sub types are available in *Devices / Workstation*:

- ♦ **0 - None**—This is the default value, however it must be changed to a 1 or 2.
- ♦ **1 - WinStation**—Select this sub type if this device is a WinStation client.
- ♦ **2 - DOS**—Select this sub type if this device is a DOS client.

To allow only authorized employees to minimize or close the WinStation Client application, two Supervisory Privileges must be enabled in the *Personnel / Employee Maintenance / Employee Class* file:

- ♦ **#49—Minimize Application**
- ♦ **#50—Close Application**

These options must be enabled to allow a user to can gain access to other applications on the workstation. These privileges also enable the use of these buttons:

- ♦ **#313 Minimize Application**—Key Type 11: Function, Key Category: General
- ♦ **#314 Close Application**—Key Type 11: Function, Key Category: General

Enable Supervisory Privileges #49 and #50 for those Employee Classes who should have access to the Windows Desktop and the authorization to close the WinStation Client application.

In addition, add a **Minimize** and a **Close** button to a touchscreen in the *Touchscreens & Keyboards / WS Touchscreens / Touchscreen Screen* file. The buttons are active only for privileged users.

When an authorized user presses the **Minimize** or **Close** button, the WinStation Client application enables the use of the shortcut keys (listed on page 2-74), and then either minimizes or closes the application. As soon as the user switches back to the WinStation Client application, those shortcut keys are disabled again.

Note *The shortcut keys for the Minimize and Close buttons are disabled while the WinStation Client application is in the foreground—even for authorized users.*

Touchscreen Icons

Identical standard sets of the DOS (.px) and WinStation (.ico) icons are included with the 9700 System software. During the installation, they are stored in the following directories:

- ♦ DOS icons: *Micros\LES\Pos\9700\xdt3\bitmaps\ws_icons*
- ♦ WinStation icons: *Micros\LES\Pos\9700\xdt3\bitmaps\winstation_icons*

If you are upgrading from 8700 or from an earlier version of 9700 (prior to Version 1.50), an identical set of .ico icons is automatically created from your set of .px icons during the upgrade. The new set of icons is placed in the *Micros\LES\Pos\9700\xdt3\bitmaps\winstation_icons* directory.

Installing the WinStation Client Application

Follow the steps below to install the WinStation Client application.

1. On the WinStation Client workstation, login as the Administrator.
2. From the Windows Desktop, select *Start / Programs / Accessories / Windows Explorer*.
3. Select *Tools / Map Network Drive*.
4. Select an available drive from the drop-down list.
5. Type the following in the **Folder** field:

```
\\Server Name \MicrosClient
```

where *Server Name* is the actual name of the server to which the WinStation Client communicates.

6. Uncheck the **Reconnect at Logon** option.
7. Click **Finish**. The network drive window displays.
8. Double-click on the *WinStation* icon  to launch the installation program.

9. The *Welcome to the InstallShield Wizard* screen displays, seen below:

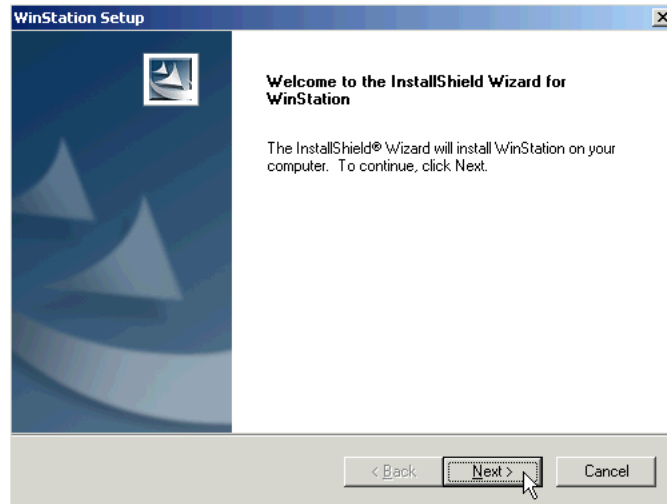

After you have read the 9700 V. 3.0 System Setup documentation, click **Next** to continue.

10. The *Customer Information* screen displays, seen below:

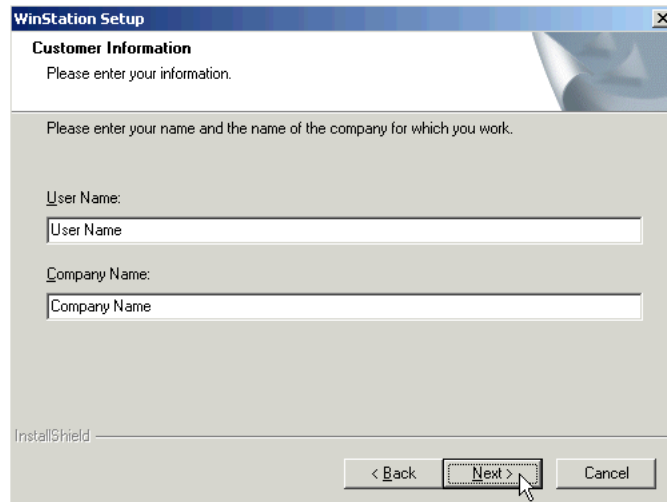

Enter the User Name and Company Name, and click **Next** to continue.

11. The *WinStation Setup Type* screen displays, seen below. Configure your system setup type based on the detailed description below:

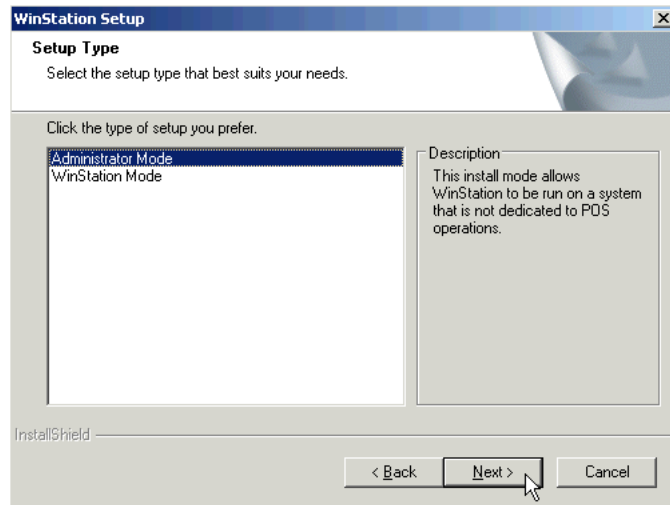

Choose the WinStation Setup Type:

- ◆ **Administrator Mode -**

Choose this option if you want this workstation to perform Windows operations in addition to workstation functions.

- ◆ **WinStation Mode -**

Choose this option if you want this workstation to *only* perform workstation functions.

Once you have determined the Setup Type for this workstation, click **Next**.

12. The *Installation Drive Selection* screen displays, seen below.

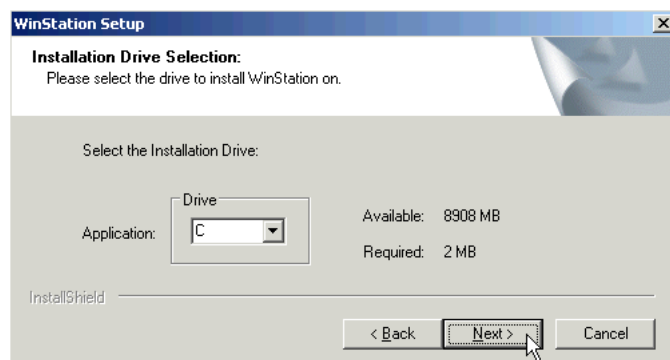

Once you have determined the Installation Drive, click **Next**.

13. The *Start Copying Files Summary* screen displays, seen below.

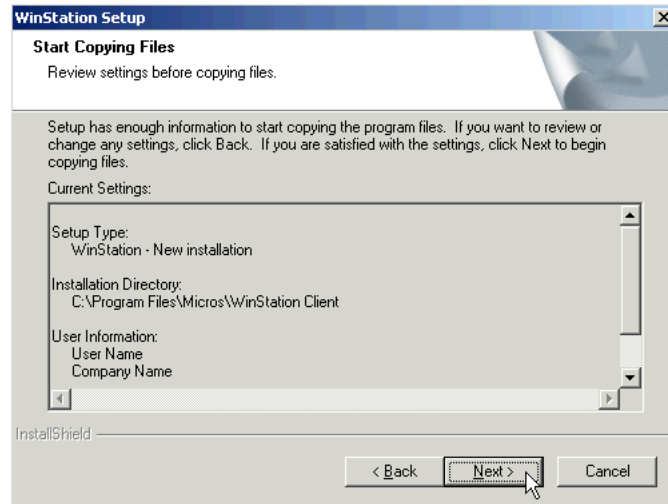

Once you have confirmed these settings, click **Next** to start the WinStation installation.

14. After a few moments the installation finishes, and the InstallShield Wizard Complete screen displays, seen below.

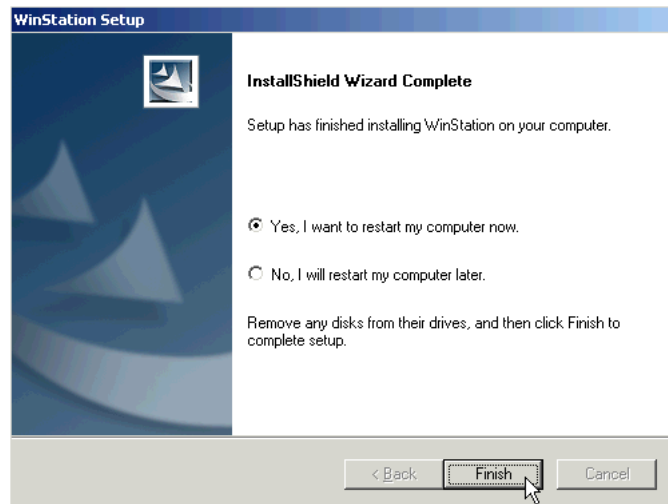

To complete the installation select **Yes, I want to restart my computer now.**, and click **Finish**.

15. Proceed to *Configuring the WinStation Client Application* on page 2-80.

Configuring the WinStation Client Application

Configuring the WinStation Client requires minimal programming on both the Server and the WinStation Client workstation.

Configure the Server

After you've installed the WinStation Client application, complete the tasks below in the EMC to configure the server.

1. Add the WinStation Client(s) to the *Device Table*. On the **Workstation** tab, the specific parameters for a WinStation client are:

- ♦ User Workstation Type = **4-PCWS**
- ♦ Sub Type = **1-WinStation**

All other programming is the same as any other workstation.

2. Enable the following privileges for all authorized Employee Classes in *Personnel / Employees / Maintenance / Sort By: Class / Privileges / Other Utilities*:

- ♦ **Can Minimize Application**
- ♦ **Can Close Application**

3. Add the **Minimize** and **Close** buttons to a touchscreen in the *Touchscreens / Workstations / Design* file. Once the buttons are added to the appropriate touchscreens, they will only function for privileged users.

The parameters for these buttons are:

- ♦ Key Type: 11 - Function
Function Key Category: General
Number: 313 - Minimize Application
- ♦ Key Type: 11 - Function
Function Key Category: General
Number: 314 - Close Application

4. Proceed to *Configure the WinStation Client Workstation* on page 2-81.

Configure the WinStation Client Workstation

Follow the steps below to establish communication between each WinStation Client workstation and the server.

1. Start the WinStation application.
2. Access the *Configuration* mode by pressing the touchscreen using the following keystroke sequence:
 - ◆ upper left corner
 - ◆ upper right corner
 - ◆ upper left corner

A six-digit number displays to the left of the **Access Code** field.

3. Apply the following formula to the six-digit number to calculate the Access Code:

Digit 1 x Digit 2 + Digit 4 + Digit 6 = Access Code

For example, if the number is 374236, the formula would be
 $3 \times 7 + 2 + 6 = 29$.

4. Type the Access Code for the workstation and press **Enter**. The Access Code provides entry to the configuration options.
5. Press the **Configuration** button.
6. Press the **PC Interface** button.
7. Press the **Set Primary Address** button.
8. Type the server's IP address in the **Primary Host TCP/IP Name** field and press **Enter**.
9. Press the **Set Primary SCC Number** button, enter the SCC range, and press **Enter**.
10. Press the **Previous Menu** button twice, then press **Yes** when you are prompted to save the changes.
11. Press the **Restart** button.
12. Repeat Steps 1 through 11 on each WinStation Client workstation in the system.

Configuring Workstation 4 (WS4) Clients

Installing the Serial Application Loader (SAL) Software

Follow the steps below to install the WS4 SAL software.

1. Power on the workstation.
2. During the boot process, a message will display, which states that a network cable is not connected. Select **OK** to continue.
3. A prompt displays, which asks if you want to *disable* the CAL (Client Application Loader). Select **Yes**.

When the boot process completes, you will be placed at the Windows Desktop.

4. Select *Start / Programs / Windows Explorer*.
5. Navigate to the `\DOC\McrsSal` folder.
6. Double-click the **McrsSal.exe** file. The Serial Application Loader (SAL) progress screen displays.
7. When the installation is complete, proceed to “Performing the Confidence Test” on page 2-83.

Performing the Confidence Test

1. On the 9700 Server, select *Start / Programs / MICROS Systems 9700 / Confidence Test*.
2. Using the left/right cursor keys, select *Programs / UWS Program / Select*.
3. Using the up/down cursor keys, select the serial workstation you just configured, and press **Enter** to select it.
4. Using the left/right cursor keys, select **Program**.
5. At this point, one of two scenarios may occur:
 - ♦ If the necessary configuration overlay file (*uws3.cfg*) does not exist, the System will display a prompt, which asks if you if one should be created. Select **Yes**.
 - ♦ If the *uws3.cfg* file already exists, you will not see a prompt to create it. After the programming process is finished, edit the file to include the path needed for the WS4 software. Refer to *Modifying the Configuration File (uws3.cfg)*, below.

Modifying the Configuration Overlay File (uws3.cfg)

Perform the following steps to add the parameters needed for the serial configuration to the *uws3.cfg* file:

1. On the 9700 server, select *Start / Programs / MICROS Systems 9700 / Confidence Test*.
2. Select *Configuration / Overlay*.
3. Using the up/down cursor keys, select the **UWS4 Default** configuration.
4. Using the left/right cursor keys, select **Modify** and then select **Enter**.
5. Press **Enter** through the *PC*, *LCC*, *CHAN*, and *RCC* lines.
6. On the **OVERLAY FILE** line, enter the following path:

```
/Micros/LES/POS/etc/9700WS4Client.x86.CAB
```
7. Press **Enter** twice.
8. Using the left/right cursor keys, select *Save / Quit / Quit / Exit*.
9. Proceed to *Configuring the WS4 Serial Client Workstation*, on page 2-84.

Configuring the WS4 Client Workstation

Perform the following steps to configure the serial client workstations:

1. Start the workstation application on the WS4. Use Windows Explorer to navigate to the `\CF` directory and double-click the **WS4.exe** file.
2. Access the *Configuration* mode. Press the touchscreen using the following keystroke sequence:
 - ♦ upper left corner
 - ♦ upper right corner
 - ♦ upper left corner

A six-digit number displays to the left of the **Access Code** field.

3. Apply the following formula to the six-digit number to calculate the Access Code:

`Digit 1 x Digit 2 + Digit 4 + Digit 6 = Access Code`

For example, if the number is 374236, the formula would be: $3 \times 7 + 2 + 6 = 29$.

4. Type the Access Code for the workstation and press **Enter**. The Access Code provides entry to the configuration options.
5. Select *Configuration / COM Ports*.
6. Set COM 4 to **Host Communications**.
7. Increase the *PC Port Baud Rate* (e.g., 38400).
8. Save and exit the *Configuration* mode.
9. Restart the workstation.

Configuring NetCCs

Converting From an 8700 System to a 9700 System

For users converting from the 8700 System to the 9700 System, the NetCC is the *replacement* for the 8700 LCC/RCC combination. LCCs must be replaced by one or more NetCCs. RCCs can still be supported in 9700 via NetCC, but please note the following:

- ◆ Up to six RCCs can be connected to a NetCC device.

Important Note *If RCC(s) are required in your system, you can only connect them to ports **1 through 6** of the NetCC. An RCC connected to port **7 or 8** is not supported.*

- ◆ In the *Device Table*, make sure the CC numbers of the RCCs that are connected to the NetCC are correct. After converting to a 9700 System, these may need to be changed from the settings they used when connected to the “old” LCC.
- ◆ For detailed information on RCCs, refer to the *8700 HMS Programming Manual* and the *8700 HMS PC Workstation Configuration & Installation Guide*.
- ◆ Refer to pages 2-95 and 2-96 for examples of a NetCC/RCC setup.

The shaded area in the diagram below identifies the difference between an LCC/RCC configuration and a NetCC/RCC configuration.

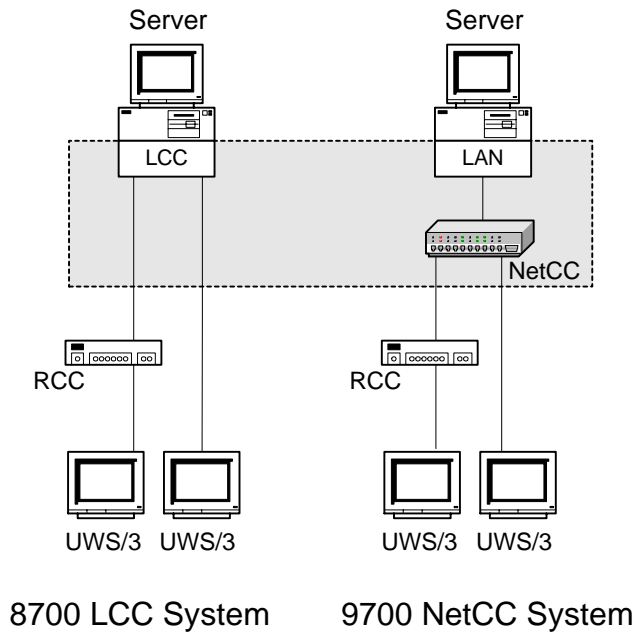

Each NetCC comes with the most current version of the NetCC application stored on the NetCC's Flash ROM. The NetCC application can also be updated using the 9700 Confidence Test.

The NetCC Hardware kit includes the document, *Installing the Network Cluster Controller*, P/N MD0006-004. Please refer to that document for detailed hardware diagrams and hardware installation instructions.

Before You Begin Setting Up a NetCC

Before you set up a NetCC, make sure that the MICROS 9700 services are running. If you encounter problems setting up the NetCC, refer to *Troubleshooting NetCCs* on page 2-92.

Check MICROS 9700 Services

Follow the steps below to verify that the 9700 services are running:

1. From the Windows Desktop, select *Start / Settings / Control Panel / Services*. The *Services* window displays.
2. Verify that the following MICROS services are running:
 - ♦ MICROS 9700 Bootp/Tftp
 - ♦ MICROS 9700 POS
 - ♦ MICROS 9700 POS Multiplexer

If any of these services do not display as *Started* in the *Status* column, click on the **Start** button to start them.

Note *In most cases, the MICROS 9700 POS and MICROS POS Multiplexer services will automatically start when the server PC is turned on. By default, the MICROS 9700 Bootp/Tftp service is set up to start manually and can be changed from the Services window by selecting Startup | Automatic | OK.*

Adding a NetCC to the 9700 System

To add a NetCC to your system, you will need to modify the *bootptab* file, and then add the NetCC's information to the *Device Table* in the 9700 Enterprise Management Console.

Modify the bootptab File

Before you modify the *bootptab* file, you will need to gather the following information about the NetCC and the server you are connecting it to:

- ♦ **Net mask**—This is your server's net mask (for example: 255.255.252.0).
- ♦ **Primary Server**—This is the IP address of the primary server.
- ♦ **Backup Server**—This is the IP address of the backup server (for multiple PC systems only).
- ♦ **MAC address**—This is the hardware address of the NetCC. You will find this on a sticker above the ports.
- ♦ **NetCC IP address**—This is the IP address of the NetCC. It can be any valid IP address you choose to assign.
- ♦ **NetCC name**—This is a host name for the NetCC (for example: netcc1).

Once you have gathered this information, follow the steps below to modify the *bootptab* file:

1. In the *X:\Micros\LES\Pos\9700\etc* directory (where *X*: is the drive where the 9700 System is installed), open the *bootptab* file with Microsoft® Notepad. The *bootptab* file will display in text format.
2. Modify the *bootptab* by entering the information below. Be sure to replace the bold and italicized entries with the actual information you've just gathered. Refer to the "Single PC System" and "Multiple (Backup) PC System" examples below.

```
.nccdefault:sm=net mask:to=auto:ht=1:\  
bf=NETCCAPP.IMG:\  
vm=rfc1084:\  
cs=PrimaryserverIP address, BackupserverIP address  
NetccName.DomainName:tc=.nccdefault:ha=MAC address:ip=NetCCIP address
```

Sample bootptab for a Single PC System

```
.nccdefault:sm=255.255.252.0:to=auto:ht=1:\  
bf=NETCCAPP.IMG:\  
vm=rfc1084:\  
cs=192.168.0.1  
netcc1.micros.com:tc=.nccdefault:ha=001001d123456:ip=192.168.0.21
```

Sample bootptab for a Multiple (Backup) PC System

```
.nccdefault:sm=255.255.252.0:to=auto:ht=1:\  
bf=NETCCAPP.IMG:\  
vm=rfc1084:\  
cs=192.168.0.1, 192.168.0.2  
netcc1.micros.com:tc=.nccdefault:ha=001001d123456:ip=192.168.0.21
```

3. Proceed to "Add the NetCC to the Device Table" on page 2-90.

Add the NetCC to the Device Table

Now you are ready to enter the NetCC's information into the *Device Table* in the 9700 Enterprise Management Console.

1. From the Windows Desktop, select *Start / Programs / Micros Systems 9700 / Enterprise Management Console*.
2. Select the Database Server and click **Connect**.
3. Enter the User Name and Password and click **Login**.
4. From the EMC, Start the Control Panel. Bring the System up by clicking on the Database radio button.
5. Select *System Hardware / Device Table*.
6. Click on the PC that the NetCC will be connected to and click  or select *Edit / Insert* from the *Menu Bar*. The following screen displays.

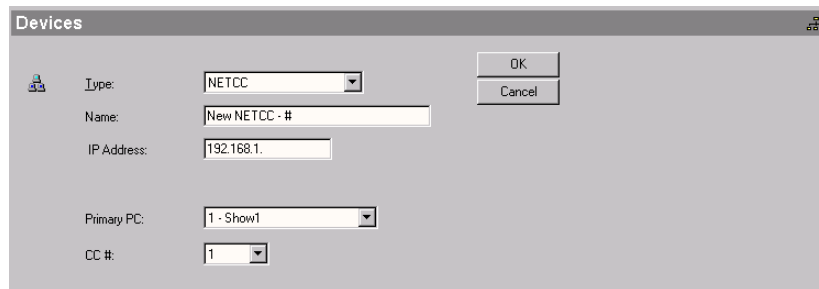

7. Select **NETCC** from the *Type* drop-down list.

Note *The fields that display on a *Devices* form are determined by the selection made in the *Type* drop-down list.*

8. Enter the name of the NetCC device in the **Name** field (overwrite the default name).
9. Enter the NetCC's IP address in the **IP Address** field (overwrite the default address).
10. Select the PC number that the NetCC is connected to in the *Primary PC* drop-down list.

The drop-down list includes all of the PCs that have been defined in the *Devices* file.

11. The **CC #** field defaults to the next available number for the selected device type. Either use the default value or select another value from the drop-down list.

Note *NetCCs and SCCs have their own unique sets of Cluster Controller Numbers. Each time you add a NetCC or SCC, the CC # drop-down list will only display the available (unused) cluster controller numbers for that device type.*

12. Click **OK**.
13. Click  or select *File / Save* from the *Menu Bar* to save the changes.

Note *If you're upgrading your system from 8700 to 9700, don't forget to update the Device Table—the CC numbers and channels of the devices you have attached to the NetCC may have changed!*

In addition, the 9700 System will not communicate with any NetCCs that do not have devices assigned to them in the Device Table.

14. Select *File / Exit* close the 9700 Enterprise Management Console.

Troubleshooting NetCCs

This section may help to answer NetCC setup questions or address a problem you experienced while setting up the NetCC.

I entered the wrong IP address for my NetCC in the *bootptab* file. Can I just open the *bootptab* file again and change it?

Sure you can! But there is one thing you need to do after you have modified and saved the *bootptab* file with the new (correct) IP address—flush the Address Resolution Protocol (ARP) cache.

The ARP is a cache that updates regularly, so you don't want to have the old IP address still in there. Follow these steps to flush the ARP cache:

1. From the Windows Desktop, select *Start / Programs / Command Prompt*. The *Command Prompt* window displays.
2. At the command prompt, type `arp -a` to view the existing IP addresses in the ARP cache.
3. Type `arp -d X` (where X is the IP address you wish to delete).

I modified the *bootptab* file. How can I make sure if I did it right?

Once you've set up the NetCC hardware and modified the *bootptab* file, you can check the following:

- ♦ **POWER and ONLINE LEDs**—The POWER LED will light up as soon as you've plugged the NetCC into the socket. About 15 seconds after plugging in the NetCC, the ONLINE LED should light up.

If the POWER LED does not light up, you may have a faulty power source.

If the ONLINE LED does not light up, you may have a defective NetCC. Contact your MICROS installer for help.

- ♦ **LINK LED**—This LED is lit when the NetCC has established a successful physical network connection with the server.

- ◆ **NetCC ping**—You can ping the NetCC using the `ping` command from the *Command Prompt* window.
 1. From the Windows Desktop, select *Start / Programs / Command Prompt*. The *Command Prompt* window displays.
 2. At the command prompt, type `ping X` (where X is the NetCC's IP address).

You should receive a message that looks something like this: *Reply from X: bytes=32 time<32ms TTL=128*. If you receive the message *Request timed out*, check the network topology to ensure that a route exists between the Bootp server and the NetCC.

Okay, so that works. Now how do I know if I've configured the NetCC correctly?

Once you have entered the NetCC's information into the *Devices* file, you can verify that the installation was a success through Confidence Test and the 9700 Control Panel.

- ◆ **Confidence Test**—Here's how would you use it to check for the NetCC:
 1. From the Windows Desktop, select *Start / Programs / Micros Systems 9700 / Enterprise Management Console (EMC)*.
 2. Select the database server, type your username and password, then click **Connect**.
 3. Once EMC opens, navigate to the Control Panel module, and click the **Database** button to bring the System up.
 4. From the Windows Desktop, select *Start / Programs / Micros 9700 / 9700 Confidence Test*. The *Confidence Test* window displays.
 5. **DEVICE TABLE** should be highlighted by default. Press **Enter**. The *Device Diagnostics* window displays.
 6. Right-arrow over to **NETCCX** (Where X is the CC number you've assigned to the NetCC) to highlight it and press **L**.

A *Loopback* box displays in the window, which lists *Send*, *Receive*, and *Timeout*. If you see the *Send* and *Receive* lines displaying numbers, you've successfully hooked the NetCC up to your system.

- ♦ **CC Table**—Use the Cluster Controllers module to check the status of NetCC. With the 9700 System up and running, click on the **CC Table** module on the left menu bar of the EMC. The *Cluster Controllers* window displays, which lists the Cluster Controllers and the status for each of them. The NetCC's status should be *Active*.
- ♦ **Additional Testing**—If the Confidence Test's Loopback for the NetCC timed out, or the *Cluster Controller Status* window listed the NetCC's status as *Down*, you can check the following:
 - ♦ Verify the NetCC's IP address in the *Devices* file matches its IP address in the *bootptab* file.
 - ♦ Verify the device connected to the NetCC (and listed in the *Devices* file) is set up and configured correctly, i.e., the Primary PC number, CC #, and CC Channel are correct.
 - ♦ Verify the NetCC's CC # matches the attached device's CC # in the *Devices* file.

NetCC/RCC—Setup Example

If you upgrade your system from 8700 to 9700, and you want to maintain the current RCCs, you'll need to connect the RCCs to the NetCCs. Then, add the NetCCs and RCCs to the *Devices* file in the 9700 Enterprise Management Console for PC1.

The sample screens below show how these devices are set up to enable NetCC/RCC.

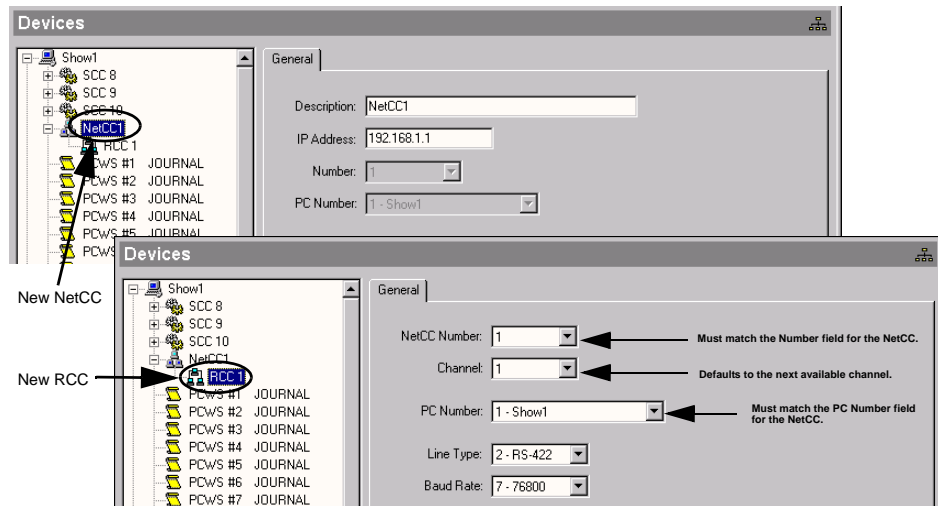

Note: RCCs can only be added to a NetCC device. If you add an RCC to any other device type, it will automatically default to the first NetCC in the *Devices* file when the changes are saved.

Once you have finished configuring the files, you can run Confidence Test and select **Device Table** to view the device status, as shown below.

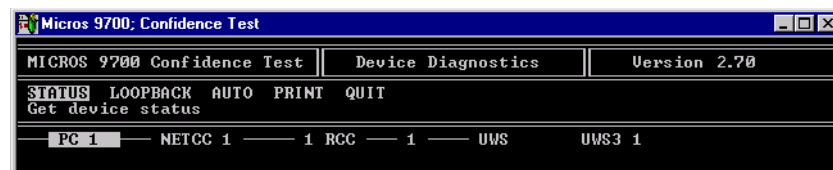

NetCC/RCC for a MICROS Operational Resiliency Pair—Setup Example

If you upgrade your system from 8700 (EBUTO enabled) to 9700 (MICROS Operational Resiliency enabled), and you want to maintain the current RCCs, you'll need to connect the RCCs to the NetCCs. Then, add the NetCCs and RCCs to the *Devices* file in the 9700 Enterprise Management Console for PC1 and PC2.

The sample screens below show how these devices are set up to enable NetCC/RCC for a MICROS Operational Resiliency pair.

NetCCs for
PC1 and PC2

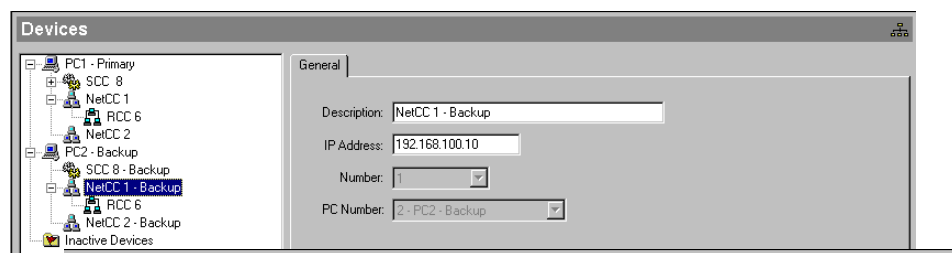

RCCs for
PC1 and PC2

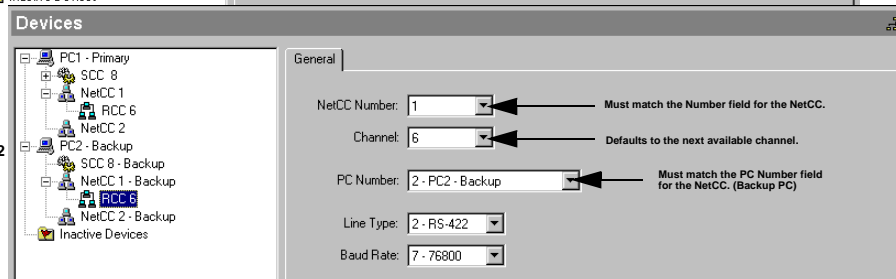

Note: RCCs can only be added to a NetCC device. If you add an RCC to any other device type, it will automatically default to the first NetCC in the Devices file when the changes are saved. In a MICROS Operational Resiliency system, make sure you select the correct PC number in the directory tree when you add the NetCCs.

Once you have finished configuring the files, you can run Confidence Test and select **Device Table** to view the device status.

Note *The backup PC will not display in Confidence Test unless it is the active PC.*

CC Table Fields for use with 8700sql

The *CC Table* is used to assign cluster controller (CC) types to cluster controller numbers, which is required to set up NetCC. It is accessible only through the *Devices* file's *Table View* mode. The fields in this table are available for SQL data import/export.

The following table summarizes the *CC Table*'s scope, availability, and file name.

9700 Database File	Scope	Export	Import	File Name
CC Table	System	Yes	Yes	CC_Table

The following table breaks down the *CC Table* database file into the subordinate fields which are used by 8700sql:

Field Name	Field Mnemonic	Type Code	Max. Width	Range
Record Number	number	N9	9	1 - 999,999,999
CC Type	cc_type	N1	1	1 - 2
CC Number	cc_number	N3	3	For SCCs: 8 - 14 For NetCCs: 1 - 7 129 - 143 145 - 159 161 - 175 193 - 207 209 - 223 225 - 239
Description	description	A32	32	0 - 32
IP Address	ip_address	A15	15	0 - 15
PC Number	pc_number	N2	2	0 - 32

Follow the steps below to view the *CC Table* in the Enterprise Management Console.

1. From the Windows Desktop, double-click on the **9700 Enterprise Management Console** icon.
2. Type a valid ID (password) in the **User ID** field and click **OK**.
3. Select *System Hardware / Devices*.
4. Click  to open *Table View*.
5. Click the *CC Table* tab at the bottom of the screen.

Backing Up the System: MS-SQL Maintenance Plans

Regardless if you have just finished upgrading your system or have a new installation, it is **strongly** recommended that you configure MS-SQL to perform a full system backup of the 9700 V. 3.0 databases and store the backups in a safe and secure place.

1. Navigate to Start | Programs | Microsoft SQL Server | Enterprise Manager, as seen below.

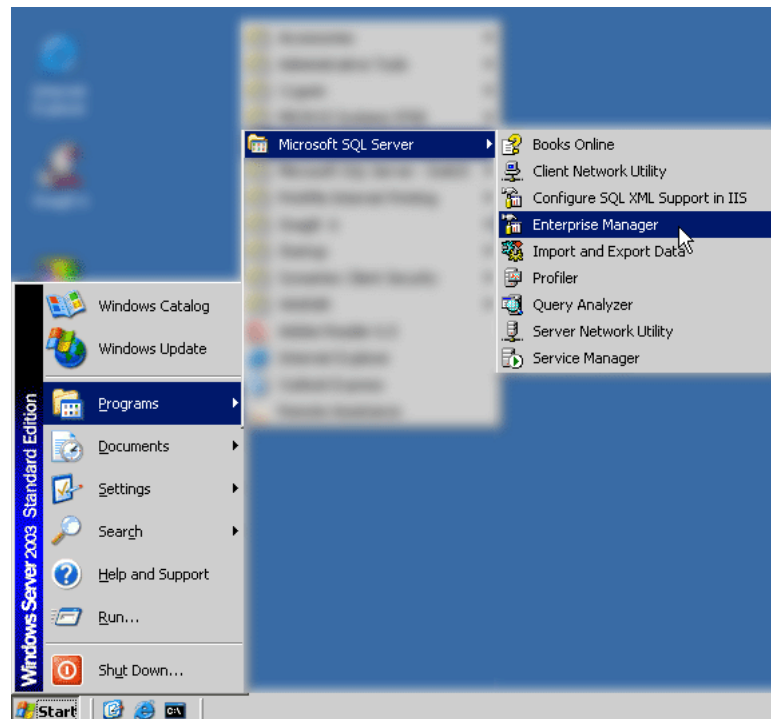

2. The SQL Server Enterprise Manager displays. In the directory tree on the left window, Expand Microsoft SQL Server | SQL Server Group | 3.0 Server Name.

Next, Expand Management | Database Maintenance Plans. The Sample Database Maintenance Plans installed with a 9700 V. 3.0 install or upgrade display, seen below.

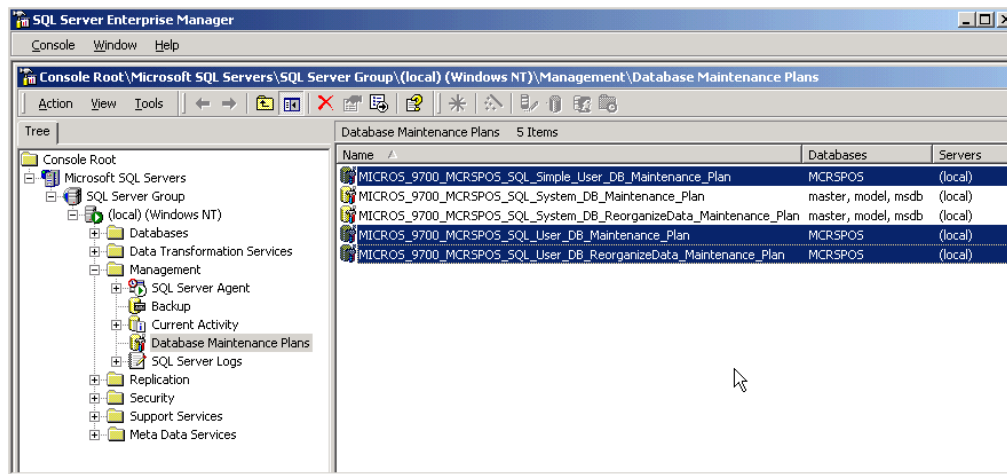

The Sample MS-SQL Database Plans installed with 9700 V. 3.0 are shown in blue above. Please follow the detailed instructions for configuring each Maintenance Plan:

- ◆ MCRSPOS SQL Simple User DB Maintenance Plan, page 2-101
- ◆ MCRSPOS SQL User DB Maintenance Plan, page 2-104
- ◆ MCRSPOS SQL User DB Reorganize Data Maintenance Plan, page 2-110

MCRSPOS SQL Simple User DB Maintenance Plan

1. Right-click on MCRSPOS SQL Simple User DB Maintenance Plan, Select Properties.
2. The Database Maintenance Plan configuration window displays (General Tab shown).

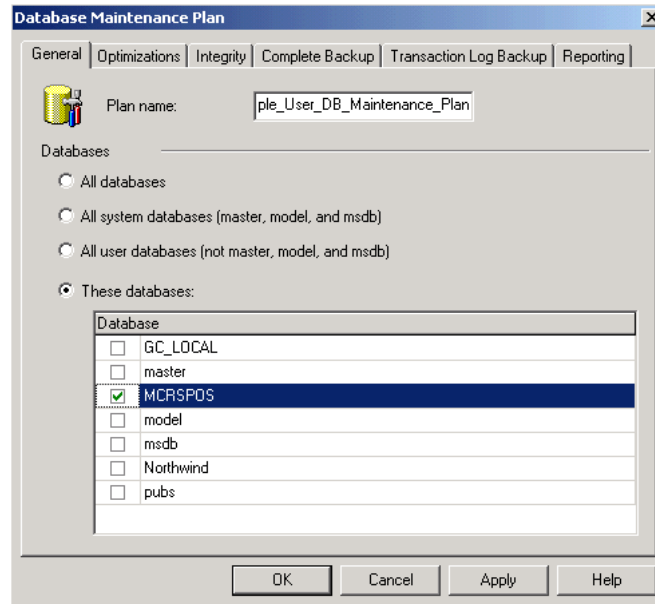

Note *To ensure proper configuration of the **MCRSPOS SQL Simple User DB Maintenance Plan**, the necessary settings for each of the six tabs seen above—General, Optimizations, Integrity, Complete Backup, Transaction Log Backup, Reporting—will be detailed in the steps below.*

If a tab is not listed, no configuration changes are needed to options on this tab.

Simple User DB Maintenance | Complete Backup Tab

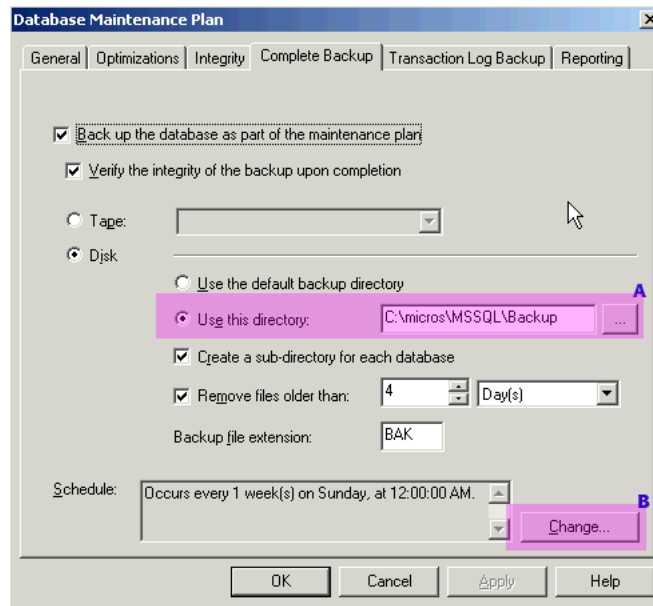

A. Change the Backup Directory

Change 'use this directory' to x:\micros\mssql\backup, where x = installation drive used for MS-SQL Server

Click Apply to save your changes

B. Change the Backup Schedule

Click Change...



The Edit Recurring Job Schedule window displays, seen below...

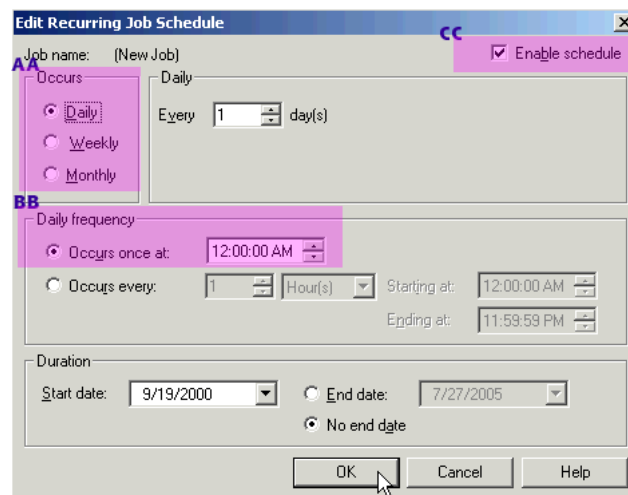

AA. Set 'Occurs' to Daily

BB. Set 'Daily Frequency' to 'Occurs Once at'

- ◆Time Dependant on SOD\EOD — set it up for 2 hours after to be safe.

CC. Check 'Enable Schedule'

Click OK, then Apply to save your changes

Simple User DB Maintenance | Reporting Tab

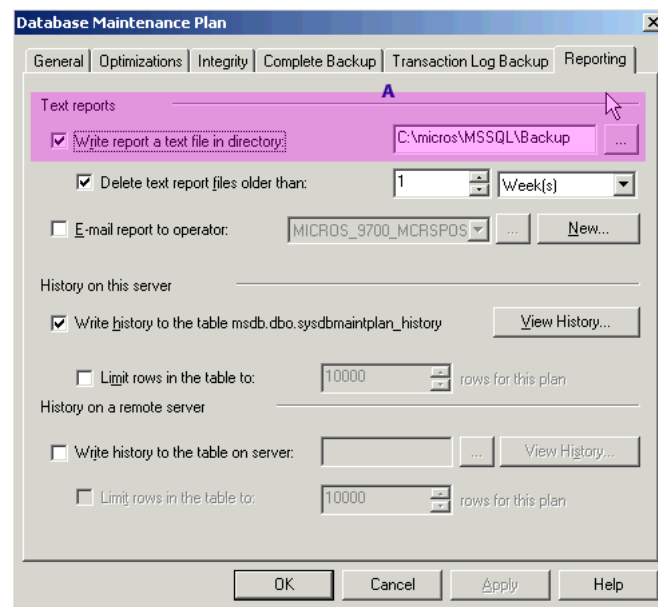

A. Select Report File Directory

Change 'Write report to a text file in directory' to x:\micros\mssql\backup, where x = installation drive used for MS-SQL Server

Click Apply, then click OK to close the configuration window.

MCRSPOS SQL User DB Maintenance Plan

1. Right-click on MCRSPOS SQL User DB Maintenance Plan, Select Properties.
2. The Database Maintenance Plan configuration window displays (General Tab shown).

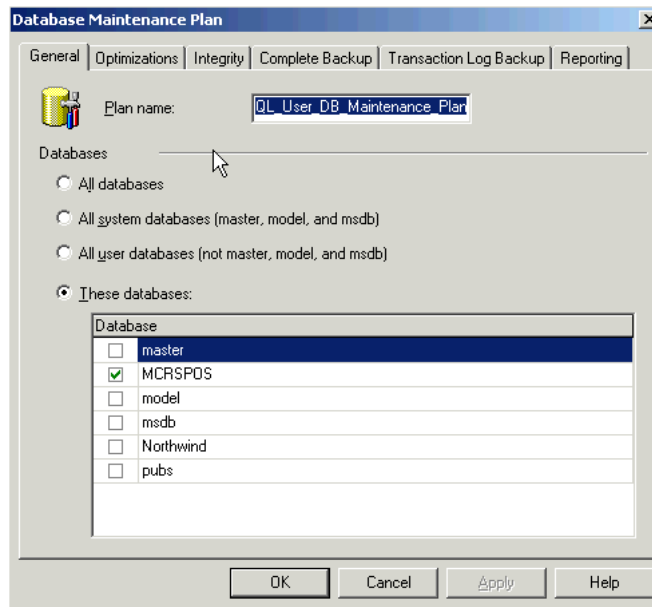

Note *To ensure proper configuration of the **MCRSPOS SQL User DB Maintenance Plan**, the necessary settings for each of the six tabs seen above—General, Optimizations, Integrity, Complete Backup, Transaction Log Backup, Reporting—will be detailed in the steps below.*

If a tab is not listed, no configuration changes are needed to options on this tab.

User DB Maintenance | Complete Backup Tab

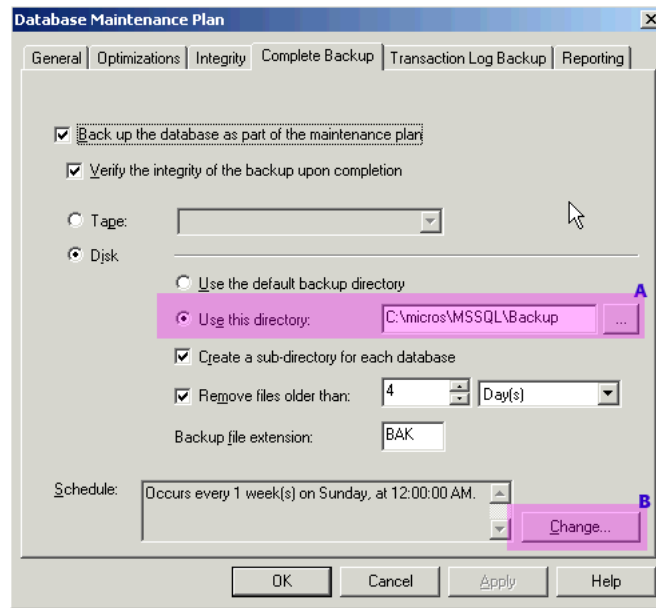

A. Change the Backup Directory

Change 'use this directory' to x:\micros\mssql\backup, where x = installation drive used for MS-SQL Server

Click Apply to save your changes

B. Change the Backup Schedule

Click Change...



The Edit Recurring Job Schedule window displays, seen below...

User DB Maintenance | Complete Backup Tab | Edit Recurring Job Schedule

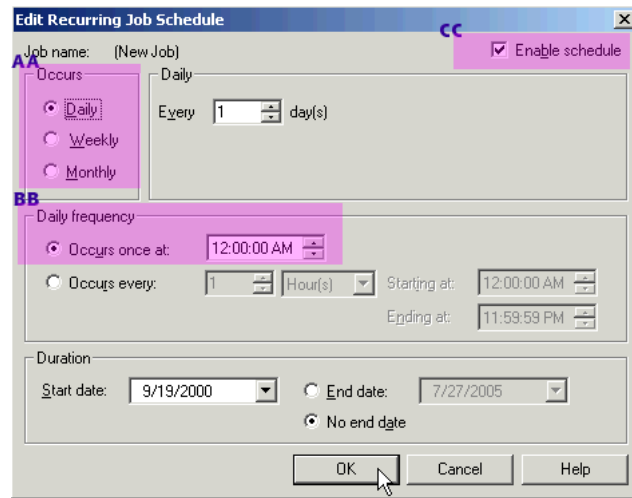

AA. Set 'Occurs' to Daily

BB. Set 'Daily Frequency' to 'Occurs Once at'

- ◆ Time Dependant on SOD\EOD — set it up for 2 hours after to be safe.

CC. Check 'Enable Schedule'

Click OK, then Apply to save your changes

User DB Maintenance | Transaction Log Backup Tab

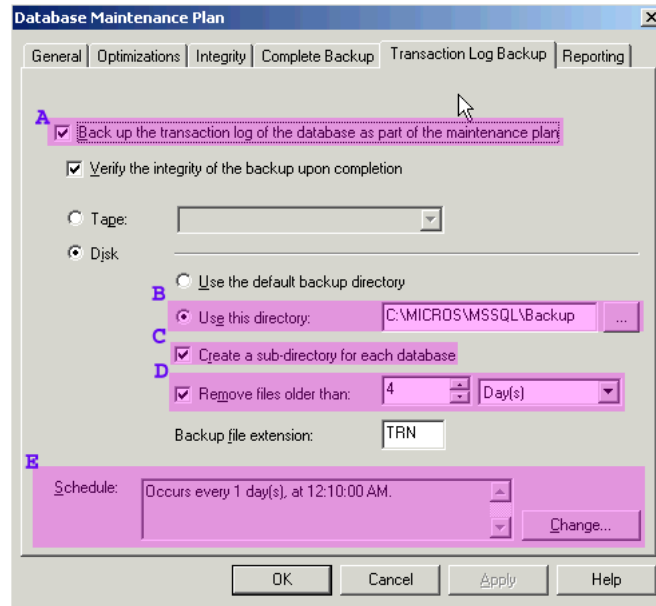

A. Backup the Transaction Log

Check 'Backup the transaction log of the database as part of the Maintenance Plan'

B. Select 'Use this directory'

Set to x:\microsof\mssql\backup, where x = installation drive used for MS-SQL Server.

C. Check 'Create a sub-directory for each database'

D. Check 'Remove files older than'

Set to 4 days

E. Change the Backup Schedule

Click Change...

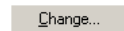

The Edit Recurring Job Schedule window displays, seen below...

User DB Maintenance | Transaction Log Backup Tab | Edit Recurring Job Schedule

Job name: (New Job) Enable schedule

Occurs: Daily Weekly Monthly

Every: 1 day(s)

Daily frequency: Occurs once at: 12:10:00 AM Occurs every: 1 Hour(s) Starting at: 12:00:00 AM Ending at: 11:59:59 PM

Duration: Start date: 7/27/2005 End date: 7/27/2005 No end date

OK Cancel Help

AA. Set 'Occurs' to Daily

BB. Set 'Daily Frequency' to 'Occurs Once at'

- ◆ Time Dependant on SOD\EOD — set it up for 2 hours 10 minutes after to be safe (this should be offset from the Complete Backup).

CC. Check 'Enable Schedule'

Click OK, then Apply to save your changes

User DB Maintenance | Reporting Tab

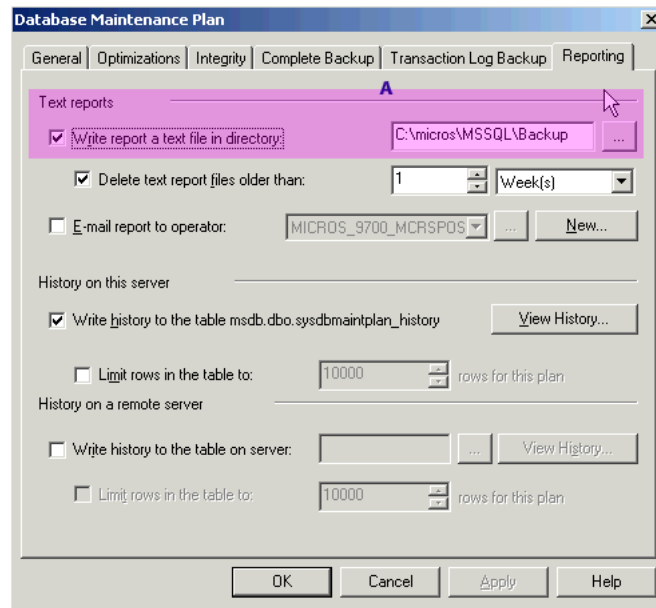

A. Select Report File Directory

Change 'Write report to a text file in directory' to x:\micros\mssql\backup, where x = installation drive used for MS-SQL Server

Click Apply, then click OK to close the configuration window.

MCRSPOS SQL User Reorganize Data Maintenance Plan

1. Right-click on MCRSPOS SQL User Reorganize Data Maintenance Plan, Select Properties.
2. The Database Maintenance Plan configuration window displays, seen below.

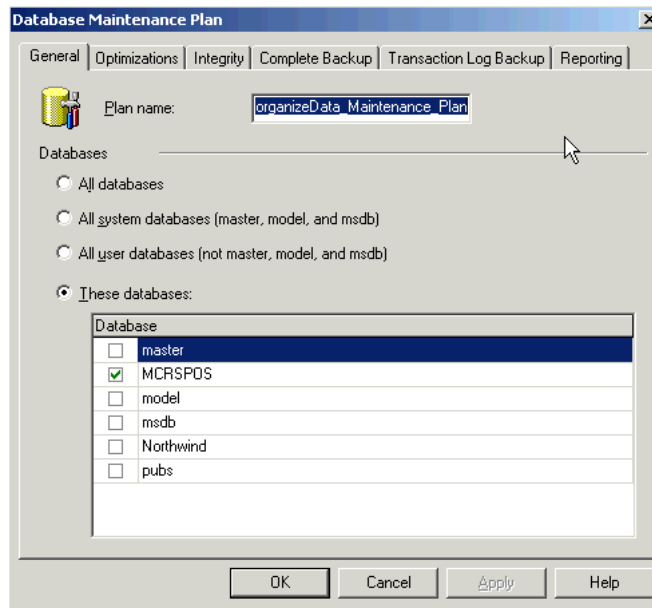

Note *To ensure proper configuration of the **MCRSPOS SQL User Reorganize Data Maintenance Plan**, the necessary settings for each of the six tabs seen above—**General**, **Optimizations**, **Integrity**, **Complete Backup**, **Transaction Log Backup**, **Reporting**—will be detailed in the steps below.*

If a tab is not listed, no configuration changes are needed to options on this tab.

Reorganize Data Maintenance | Optimizations Tab

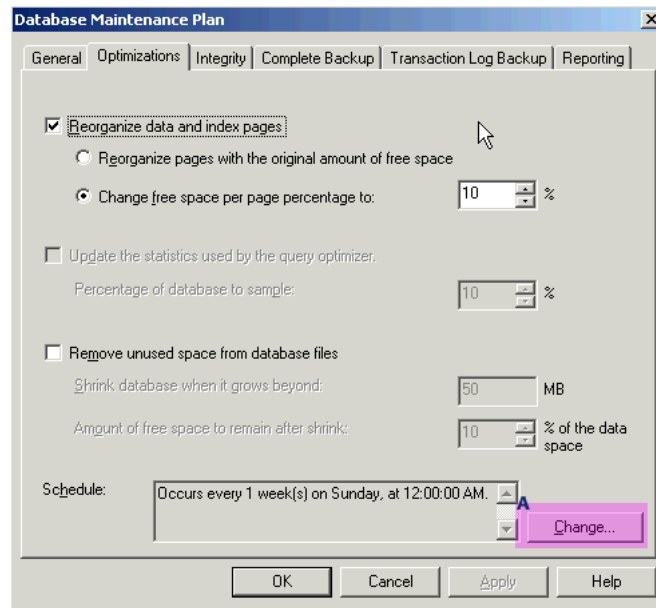

A. Change the Backup Schedule

Click Change...



The Edit Recurring Job Schedule window displays, seen below...

Reorganize Data Maintenance | Optimizations Tab | Edit Recurring Job Schedule

Edit Recurring Job Schedule

Job name: (New Job) Enable schedule

Occurs: Daily Weekly Monthly

Daily: Every 1 day(s)

Daily frequency:

Occurs once at: 12:10:00 AM

Occurs every: 1 Hour(s) Starting at: 12:00:00 AM

Ending at: 11:59:59 PM

Duration:

Start date: 7/27/2005 End date: 7/27/2005

No end date

OK Cancel Help

A. Check 'Enable Schedule'

Click OK, then Apply to save your changes, and OK to exit.



3

Software Maintenance

In This Chapter

This chapter discusses the maintenance of the 9700 System software. Specifically, this includes what you'll need to do to upgrade your existing MICROS 8700 HMS or 9700 HMS System to the latest version of 9700 software, MS-SQL or Oracle.

This section also includes instructions on how to upgrade MICROS peripheral applications—the Remote Management Console, the BootP service, and the WinStation client application.

Upgrading to 9700 V. 3.0.....	3-2
MS-SQL Upgrades	3-3
Oracle Upgrades	3-33
Upgrading MICROS Peripheral Applications	3-63

Upgrading to 9700 V. 3.0

This section of the system setup manual covers upgrades from previous version of MICROS HMS. Before you attempt to upgrade to the latest version of MICROS 9700 HMS, check to ensure your server and hardware configuration are consistent with the information detailed in the “9700 v 3.0 Server Sizing” document, available on the MICROS product page. 9700 V. 3.0 requires that your Windows Operating System be either Windows 2000 Server with SP4 or Windows 2003 Server. Please refer to your Windows documentation for proper upgrade protocol.

Please select your appropriate upgrade configuration from the options below:

- ◆ For MS-SQL upgrades please refer to page 3-3.
- ◆ For Oracle upgrades please refer to page 3-33.
- ◆ For MICROS peripheral application upgrades please refer to page 3-63.

MS-SQL Upgrades

This section details the three scenarios of MS-SQL upgrades:

- ◆ For a detailed description of upgrading a previous version of 9700 to 9700 V. 3.00 using the *same* server, refer to:

“Previous Version of 9700 —> 9700 Version 3.0 MS-SQL, using existing 9700 Server” on page 3-4

- ◆ For a detailed description of upgrading a previous version of 9700 to 9700 V. 3.00 using a *different* server, refer to:

“Previous Version of 9700 —> 9700 Version 3.0 MS-SQL, using new 9700 Server” on page 3-16

- ◆ For a detailed description of upgrading an 8700 system to 9700 V. 3.00 using a *different* server, refer to:

“8700 —> 9700 V. 3.0 MS-SQL” on page 3-24

Note *Detailed instructions for upgrading MICROS peripheral applications, such as:*

*-Remote Management Console
-BootP Server
-WinStation Client*

Can be found at “Upgrading MICROS Peripheral Applications” on page 3-63.

Previous Version of 9700 —>

9700 Version 3.0 MS-SQL, using *existing* 9700 Server

Before you begin

Prior to any 9700 upgrade, you must perform the following tasks to ensure data integrity:

- Take a full backup of your system.
- Close all open guest checks.
- Run End-of-Day.
- Settle all credit card batches.
- Clear all guest checks.
- Reset the Audit Trail log.

The Upgrade Procedure

Follow the upgrade procedures in the order listed below.

- ◆ Shutdown the 9700 System from the 9700 Control Panel (page 3-5).
- ◆ Stop the MICROS services from the Windows Control Panel (page 3-6).
- ◆ Backup the system (page 3-6).
- ◆ Upgrade to Windows 2000 Server with SP4 or Windows 2003 Server, please refer to your Windows documentation for proper installation procedure.
- ◆ Install MS-SQL Server 2000 with SP3. For detailed instructions, please see “Installing the Database Server” on page 2-11.
- ◆ Install 9700 V. 3.0 on the server (page 3-7).
- ◆ Install the latest 9700 V. 3.0 Service Pack.

- ◆ Backup the system (page 3-23).

Note *If you are upgrading an EBUTO system and plan to use MICROS Operational Resiliency, you must upgrade the Primary PC **first**.*

*If you are upgrading a single PC, you **cannot** upgrade it to a MICROS Operational Resiliency system. The upgrade process can only upgrade similar system configurations (i.e., upgrade a single PC to a single PC).*

To upgrade a single PC system to a MICROS Operational Resiliency system, you must re-install the 9700 HMS software from scratch, and follow the prompts to configure a MICROS Operational Resiliency pair.

Shutdown the 9700 System

Before you begin the upgrade, make sure the 9700 System is shutdown.

Follow the steps below to shutdown the 9700 System.

1. From the Windows Desktop, select *Start / Programs / MICROS Systems 9700 / Control Panel*.

-OR-

Double-click on the **Control Panel** icon on your desktop.

2. Type a valid ID (password) and press **Enter**.
3. Click the **System** button, and then click **OK** to shutdown the system.
4. Proceed to *Stop the MICROS Services* below.

Stop the MICROS Services

Before you begin the upgrade, make sure the MICROS services are shut down.

Follow the steps below to stop the services.

1. On the 9700 server, from the Windows Desktop, select *Start / Settings / Control Panel / Administrative Tools*.
2. Double-click on **Services**.
3. Stop the following services:
 - ♦ MICROS 9700 POS
 - ♦ MICROS 9700 Multiplexer
 - ♦ MICROS 9700 Bootp/Tftp
4. Close the *Services* window.
5. Proceed to *Backup the System* below.

Backup the System

Before you begin the upgrade, it is **strongly** recommended that you perform a full system backup, and store the backup in a safe and secure place. As a safety precaution, take a full backup of the pc1 folder.

After the system and database are backed up, proceed to “Upgrading your Previous 9700 System to a 9700 V. 3.0 System with MS-SQL” on page 3-7.

Upgrading your Previous 9700 System to a 9700 V. 3.0 System with MS-SQL

After you have backed up the previous 9700 system and database, upgraded your operating system to Windows 2000 Server with SP4 or Windows 2003 server, and installed MS-SQL, you're ready to upgrade to 9700 V. 3.00. Please note that your existing database will be automatically upgraded during the installation process.

1. Close all programs and return to the *Windows Desktop*.
2. Insert the 9700 Version 3.0 CD into the PC's CD-ROM drive. The *9700 HMS* splash screen displays briefly...



...and then the main installation screen, the *Welcome to the InstallShield Wizard for 9700 HMS* screen displays, seen below.

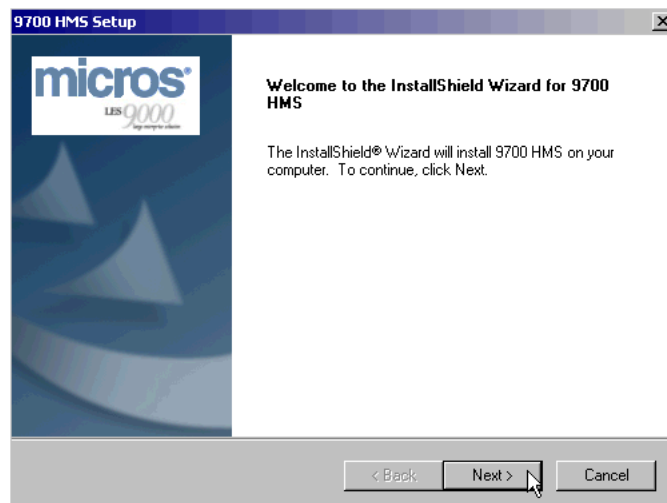

3. After reading the 9700 V. 3.0 System Setup documentation, click **Next** to continue the installation.
4. The Select the *Database Type* screen displays, seen below.

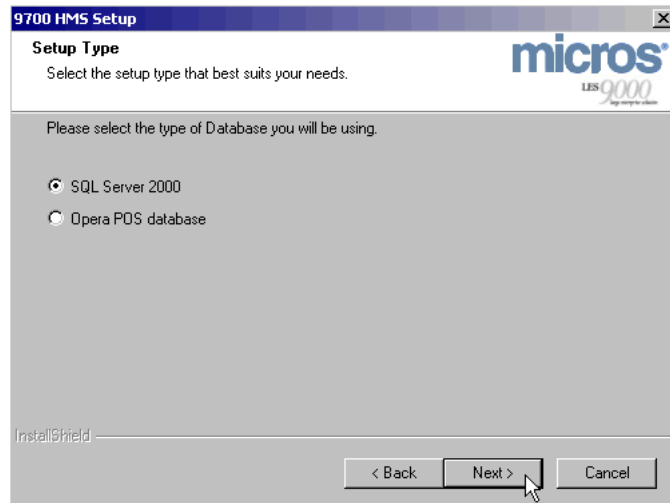

Select **SQL Server 2000**, then click **Next** to continue.

5. The *Database Information* screen displays, (Local Machine configuration shows) seen below. Configure the screen according to the installation parameters detailed below:

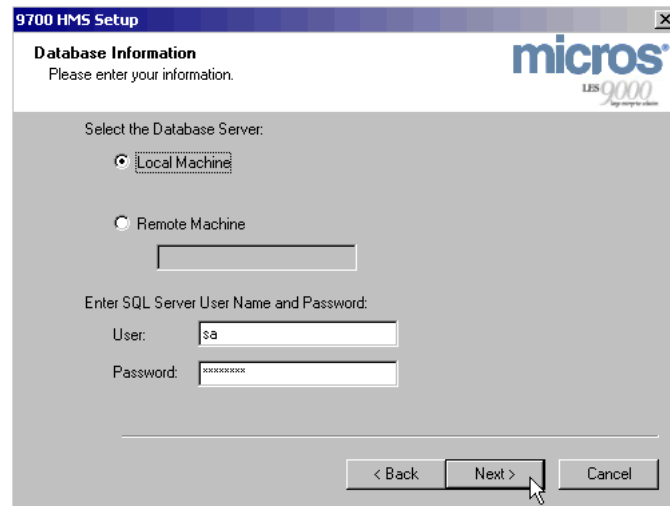

Select the Database Server:

- ◆ **Local Machine** - choose this option if Microsoft SQL Server is located on the server you are installing 9700 Version 3.0 on, i.e., a local installation.
- ◆ **Remote Machine** - choose this option if Microsoft SQL Server is *NOT* located on the server you are installing 9700 Version 3.0 on, i.e., a remote installation off the site's network. Enter the computer name or the static IP address to identify the MS-SQL server on the network.

Enter SQL Server User Name and Password:

- ◆ **User** - MICROS uses the default **sa**. If the site is providing their own instance of Microsoft SQL Server, consult site IT for the MS-SQL User Name.
- ◆ **Password** - MICROS uses the default **mymicros**. If the site is providing their own instance of Microsoft SQL Server, consult site IT for the MS-SQL Password.

Once you have configured this screen accordingly, click **Next** to continue.

6. The *Database Name* screen displays, seen below.

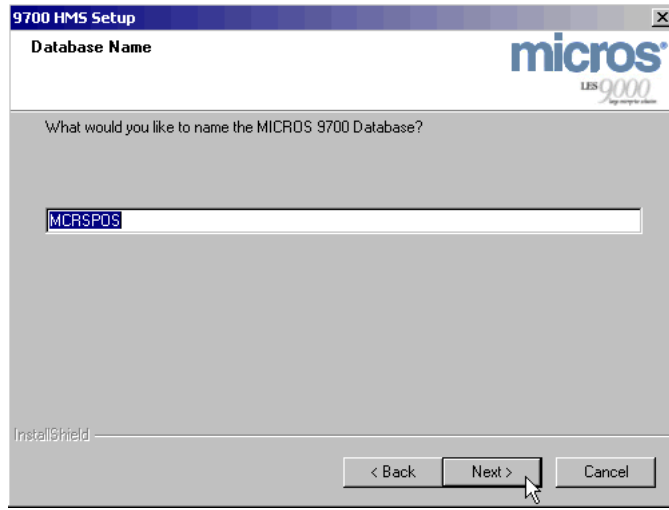

The screenshot shows a window titled "9700 HMS Setup" with a "Database Name" section. The text asks, "What would you like to name the MICROS 9700 Database?". A text input field contains the text "MCRSPOS". The MICROS logo and "LIS 9000" are visible in the top right. At the bottom, there are buttons for "< Back", "Next >", and "Cancel". The "Next >" button is highlighted with a mouse cursor. The "InstallShield" logo is in the bottom left corner.

The default Database Name is **MCRSPOS**. If you wish to change the name, type the new name into the field. Once you have decided the Database Name, click **Next** to continue.

7. The *MICROS Database Owner* screen displays, seen below. Enter the name and password for the User that will own the MICROS MS-SQL database.

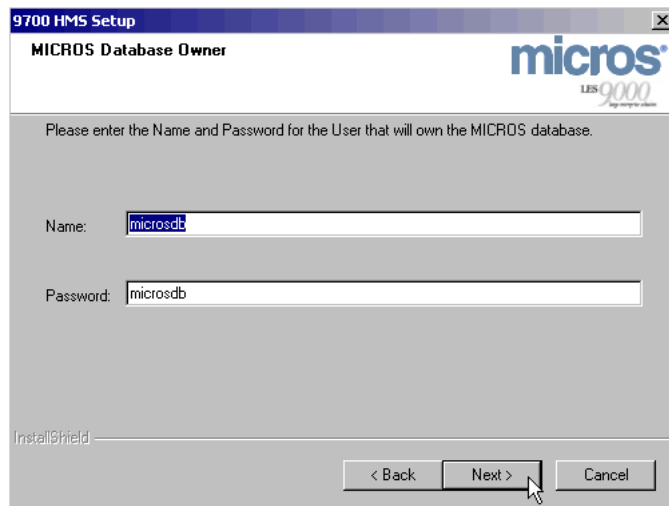

The screenshot shows a window titled "9700 HMS Setup" with a "MICROS Database Owner" section. The text asks, "Please enter the Name and Password for the User that will own the MICROS database.". There are two text input fields: "Name:" with "microsdb" and "Password:" with "microsdb". The MICROS logo and "LIS 9000" are visible in the top right. At the bottom, there are buttons for "< Back", "Next >", and "Cancel". The "Next >" button is highlighted with a mouse cursor. The "InstallShield" logo is in the bottom left corner.

The default Database Owner User Name and Password are both **microsdb**. If you wish to change the User Name or Password, change the values now. Once you have decided the Database Owner User Name and Password, click **Next** to continue the installation.

- The *SQL Server Database File Location* screen displays, seen below. Select the Folder where you would like the SQL Server Database files to be saved.

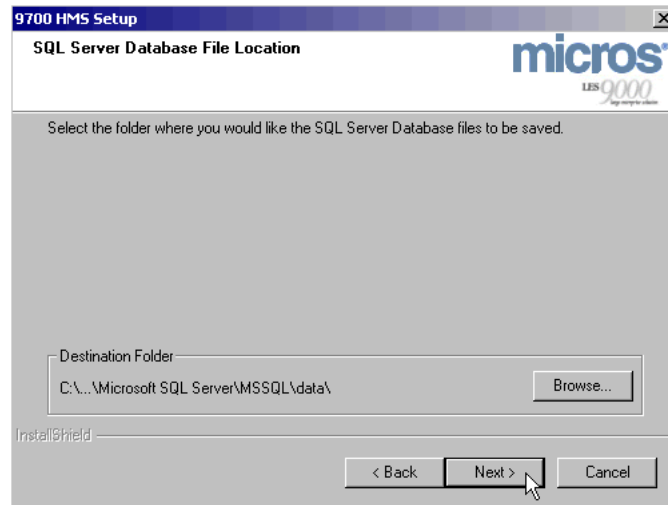

Accept the default location, or click **Browse** to select a different location. Once you have selected the Destination Folder, click **Next** to continue the installation.

- A *9700 HMS Setup* status message displays, seen below.

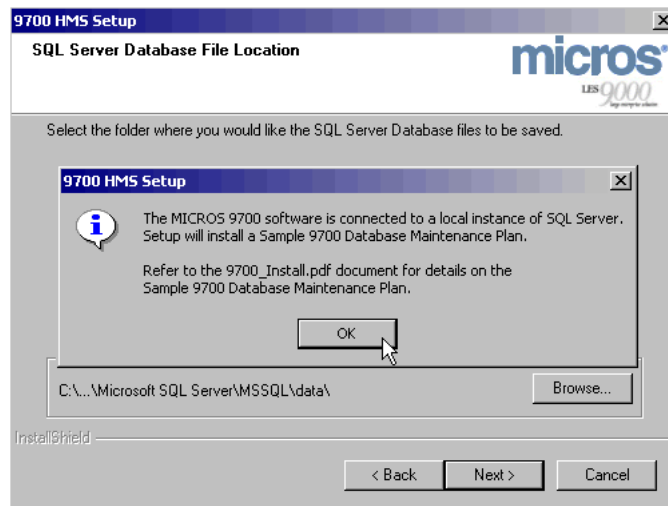

This message informs the user that Setup will install a Sample 9700 Database Maintenance Plan. For details on the Sample 9700 Database Maintenance plan, refer to “Backing Up the System: MS-SQL Maintenance Plans” on page 2-99. After you have read this message, click **Next** to continue.

10. The *Backup Destination Path* screen displays, seen below.

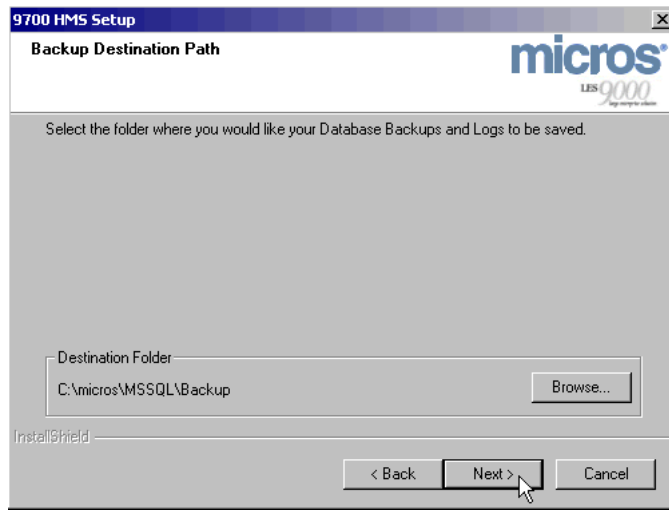

Accept the default location, or click **Browse** to select a different location. Once you have selected the Destination Folder, click **Next** to continue the installation.

11. The *9700HMS Upgrade Installation Summary* screen displays, seen below.

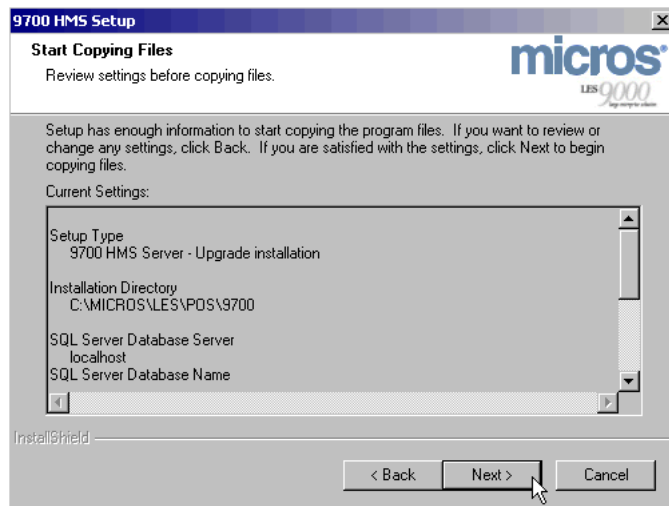

This screen provides a summary of all the parameters defined in the previous steps. Review these settings to make sure these are the correct installation parameters. Once you have verified these settings, click **Next** to continue the installation.

12. After you click **Next**, a 9700 HMS Setup Status message appears.

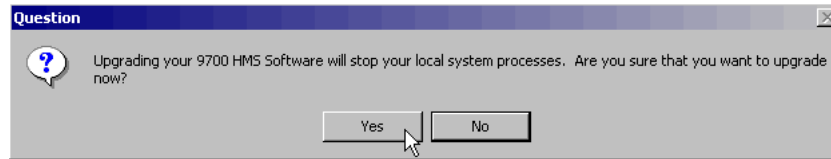

Once you have read the Note above, click **Yes** to continue the installation. If you do not wish to upgrade at this time, because it will stop your local system processes, click **No** to abort the installation.

Once you click **Yes**...

13. ...The installation starts. Status windows allow the user to monitor the progress of the installation. 9700 Version 3.0 first installs Cygwin, seen below

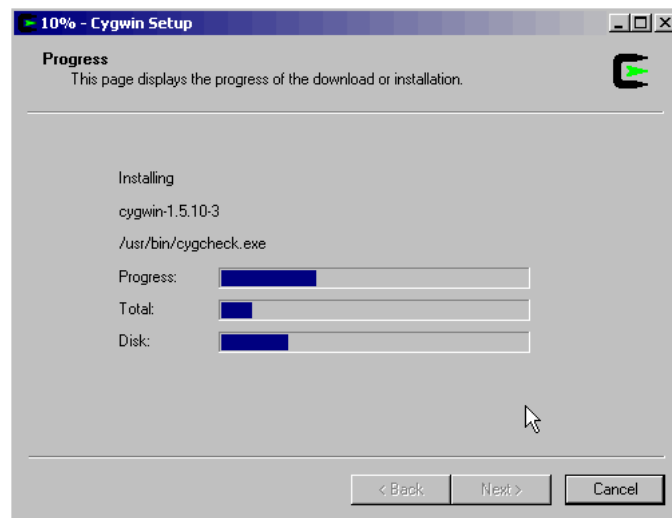

...Once the Cygwin installation completes, 9700 Version 3.0 begins installing the 9700 Server files, seen below...

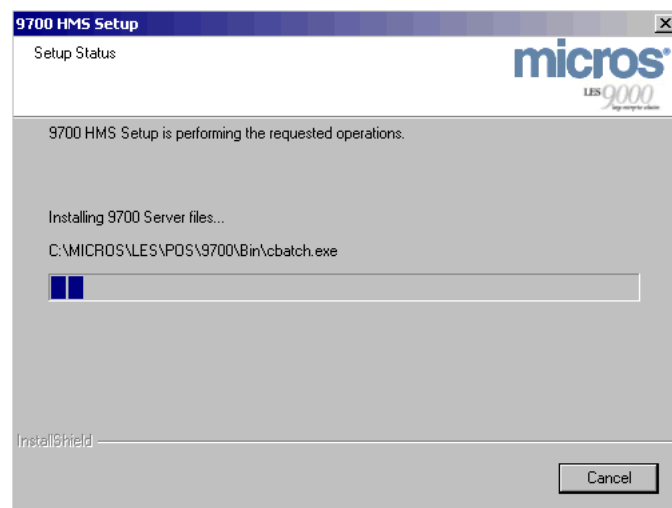

14. A 9700 HMS Setup Status message displays, seen below.

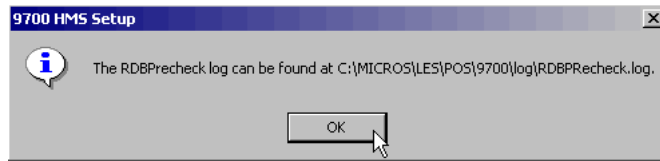

This message notifies the user of the location of the RDBPrecheck log. This log records modifications made to the pre-3.0 database. Some modifications may be necessary to ensure referential integrity between for the 3.0 system. Click **Next** to continue.

15. A 9700 HMS Setup Status message displays, seen below.

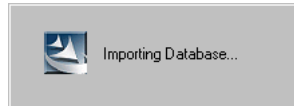

16. A status notification message displays, seen below.

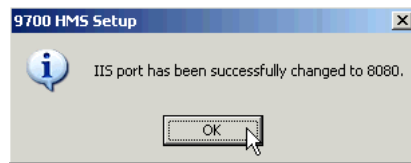

This message notifies the user that the IIS port has been changed to 8080. To continue the installation, click **OK**.

17. A status notification message displays, seen below.

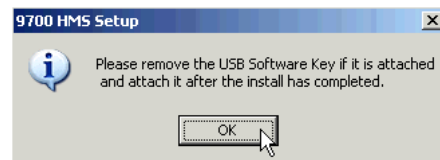

If there is a USB Software Key attached to the server, please remove it from the server now, and attach it after the installation has completed. Once you have removed the USB Software Key, if applicable, click **OK** to continue.

18. After a few moments, the *InstallShield Wizard Complete* screen displays, seen below.

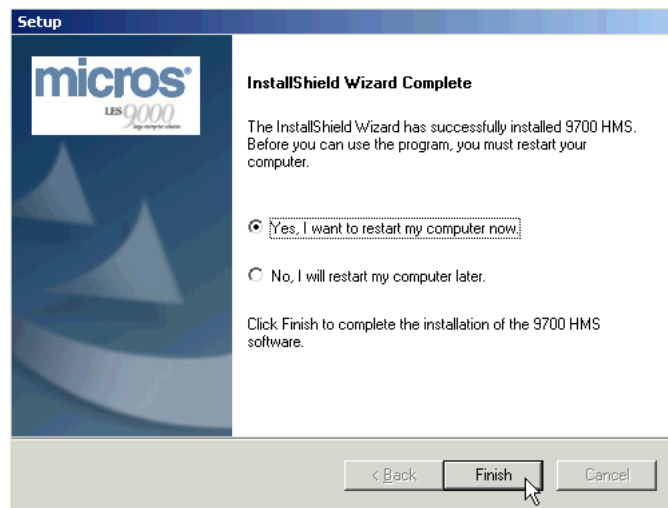

To complete the 9700 Version 3.0 upgrade installation, select **Yes, I want to restart my computer now.**, then click **Finish**.

Previous Version of 9700 —>

9700 Version 3.0 MS-SQL, using *new* 9700 Server

Before you begin

Prior to any 9700 upgrade, you must perform the following tasks to ensure data integrity:

- Take a full backup of your system.
- Close all open guest checks.
- Run End-of-Day.
- Settle all credit card batches.
- Clear all guest checks.
- Reset the Audit Trail log.

The Upgrade Procedure

Follow the upgrade procedures in the order listed below.

- ◆ On the New Server, install Windows 2000 Server with SP4 or Windows 2003 Server. Please refer to your Windows documentation for proper installation procedure.
- ◆ On the New Server, install MS-SQL Server 2000 with SP3 or Oracle 9i (the database server does not *need* to be installed locally, but *must* be available on the network)
- ◆ On the New Server, install 9700 V. 3.0.
- ◆ On the New Server, install the latest 9700 V. 3.0 Service Pack.
- ◆ On the Old Server, shutdown the 9700 System from the 9700 Control Panel.
- ◆ On the Old Server, stop the MICROS services from the Windows Control Panel.
- ◆ Backup both systems.
- ◆ Make sure both PC's are on the Network.

- ◆ On the Old Server, Copy the pc1 directory to the \MICROS\LES\POS\9700 directory of the New Server. You can do this by ftp, or since both PC's are on the network, by a direct copy and paste.
- ◆ On the New Server, run the Database Conversion Utility.

Note *If you are upgrading an EBUTO system and plan to use MICROS Operational Resiliency, you must upgrade the Primary PC first.*

*If you are upgrading a single PC, you **cannot** upgrade it to a MICROS Operational Resiliency system. The upgrade process can only upgrade similar system configurations (i.e., upgrade a single PC to a single PC).*

To upgrade a single PC system to a MICROS Operational Resiliency system, you must re-install the 9700 HMS software from scratch, and follow the prompts to configure a MICROS Operational Resiliency pair.

Shutdown the 9700 System

Before you begin the upgrade, make sure the 9700 System is shutdown.

Follow the steps below to shutdown the 9700 System.

1. From the Windows Desktop, select *Start / Programs / MICROS Systems 9700 / Control Panel*.

-OR-

Double-click on the **Control Panel** icon on your desktop.

2. Type a valid ID (password) and press **Enter**.
3. Click the **System** button, and then click **OK** to shutdown the system.
4. Proceed to *Stop the MICROS Services* below.

Stop the MICROS Services

Before you begin the upgrade, make sure the MICROS services are shut down.

Follow the steps below to stop the services.

1. On the 9700 server, from the Windows Desktop, select *Start / Settings / Control Panel / Administrative Tools*.
2. Double-click on **Services**.
3. Stop the following services:
 - ♦ MICROS 9700 POS
 - ♦ MICROS 9700 Multiplexer
 - ♦ MICROS 9700 Bootp/Tftp
4. Close the *Services* window.
5. Proceed to *Backup the System* below.

Backup the System

Before you begin the upgrade, it is **strongly** recommended that you perform a full system backup, and store the backup in a safe and secure place. As a safety precaution, take a full backup of the pc1 folder.

Decompressing the Previous 9700 Database

Before you run the MICROS Database Conversion Utility, the previous database must be on the 9700 V. 3.00 server, and decompressed (if appropriate) from the tar.Z format. To decompress the previous 9700 database, follow the steps listed below:

Note *If you have already decompressed your previous 9700 database, or elected to directly copy the pc1 directory over the network, please proceed to “Using the Database Conversion Utility” on page 3-21*

1. Close all programs and return to the Windows Desktop.
2. On the 9700 V. 3.0 server, navigate to \MICROS\LES\POS\9700, seen below. Make sure the database from the previous 9700 system is located here (seen below). As a safety precaution, rename the existing pc1 directory (seen below).

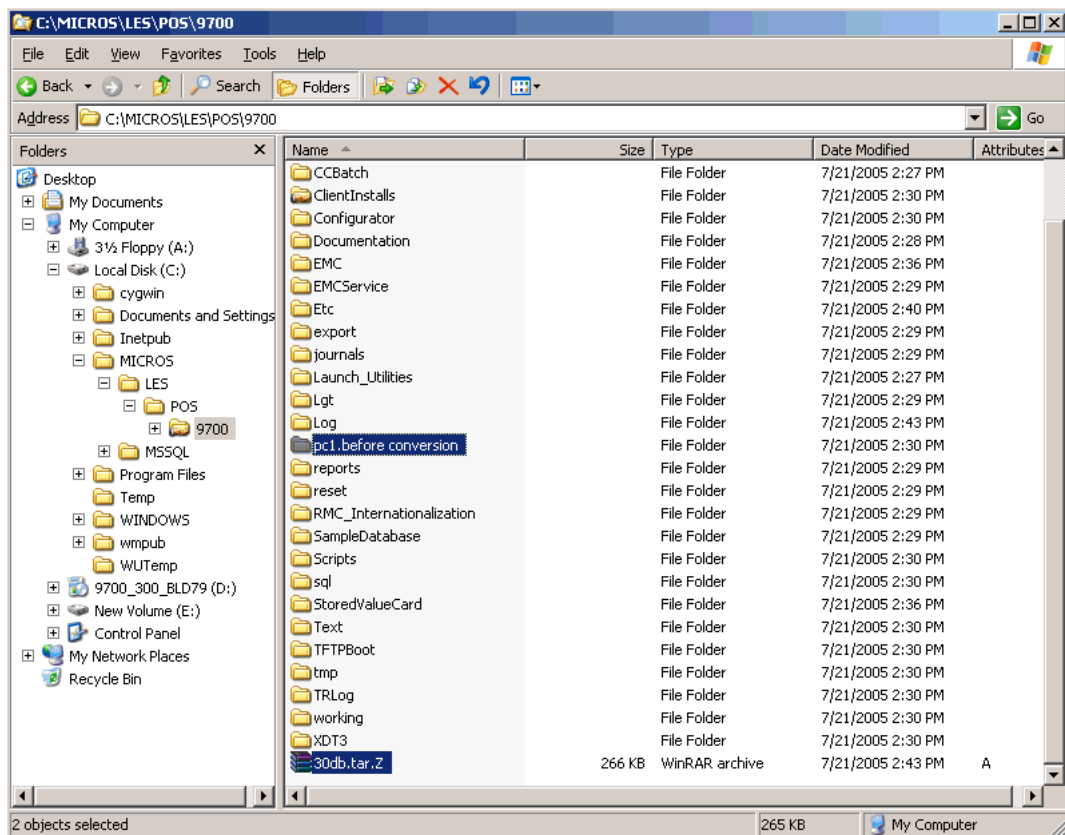

3. Once you have verified the previous 9700 database file is present, and you have renamed the previous pc1 directory, open a Cygwin shell prompt.

- Once in the \MICROS\LES\POS\9700 directory, decompress the previous 9700 database using the Cygwin shell prompt, as seen below.

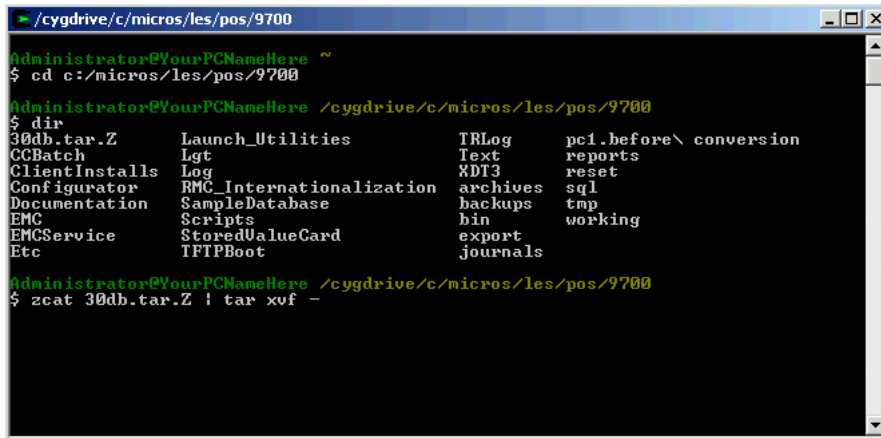

```
Administrator@YourPCNameHere ~
$ cd c:/micros/les/pos/9700
Administrator@YourPCNameHere /cygdrive/c/micros/les/pos/9700
$ dir
30db.tar.Z      Launch_Utilities      TRLog      pc1.before\ conversion
CCBatch        Lgt                   Text       reports
ClientInstalls Log                   XDT3       reset
Configurator   RMC_Internationalization archives    sql
Documentation   SampleDatabase        backups    tmp
EMC             Scripts               bin        working
EMCSERVICE     StoredValueCard      export
Etc            TFTPBoot              journals

Administrator@YourPCNameHere /cygdrive/c/micros/les/pos/9700
$ zcat 30db.tar.Z | tar xvf -
```

To decompress the previous 9700 database, enter the UNIX command, **zcat filename | tar xvf -** (where filename = database name), then press **Enter**.

- The file decompression process begins...After a few moments, the decompression process completes, and you will be returned to the “\$” prompt.

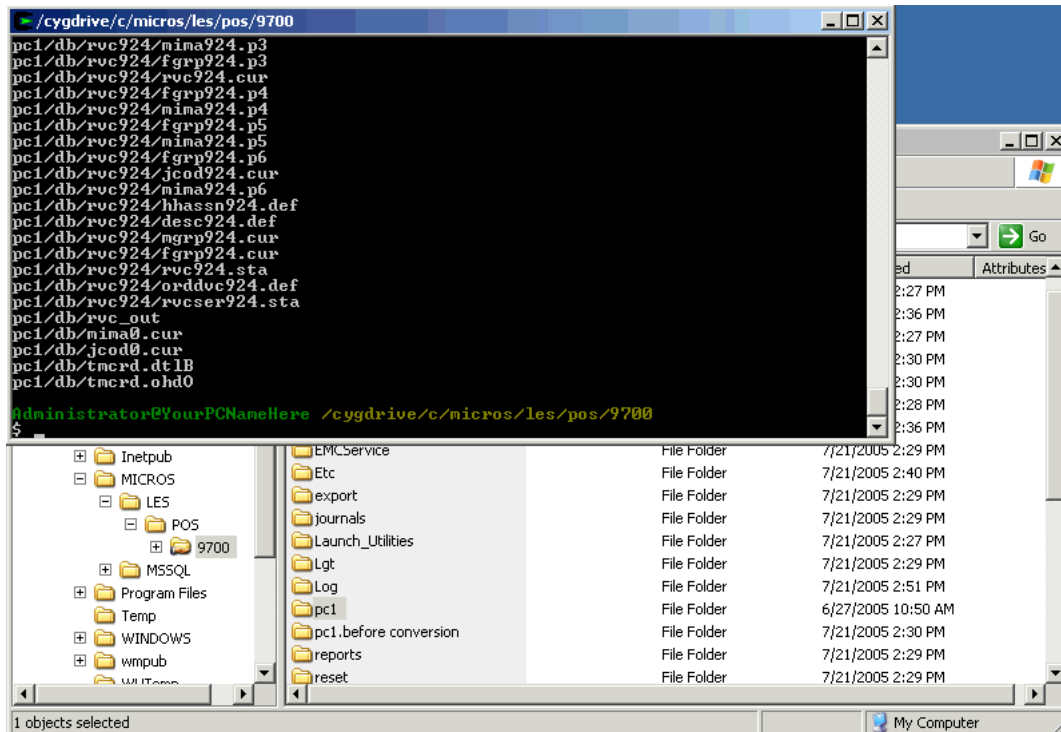

Please note that this process creates a new pc1 directory.

- Once you have decompressed the previous 9700 database, continue to “Using the Database Conversion Utility”.

Using the Database Conversion Utility

Because of the switch to an open database platform, the previous 9700 database cannot be used until the database conversion utility has been run. During the upgrade of the previous database to 9700 V. 3.0, the previous 9700 system configuration is preserved. To use the Database Conversion Utility, follow the instructions below:

1. Close all programs and return to Windows Desktop.
2. Go to the Windows Start Menu | Programs | MICROS Systems 9700 | Database Conversion, as seen below.

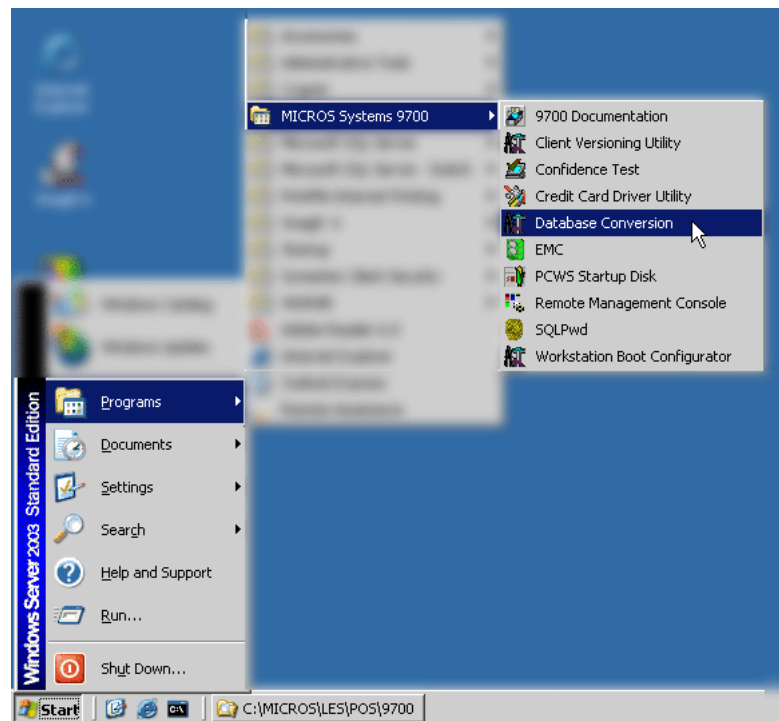

3. The Database Conversion Utility appears, seen below.

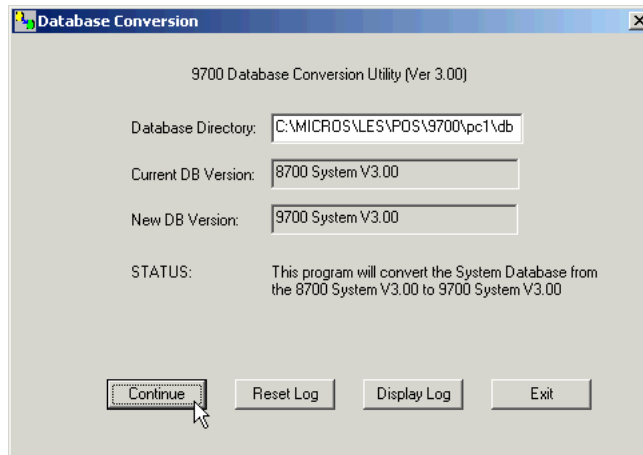

The Utility recognizes the previous database version (Current DB Version field), and indicates what version (New DB Version field) it will be upgraded to. Once you have reviewed these settings, Click **Continue** to begin the conversion process.

4. A Database Conversion message appears, seen below.

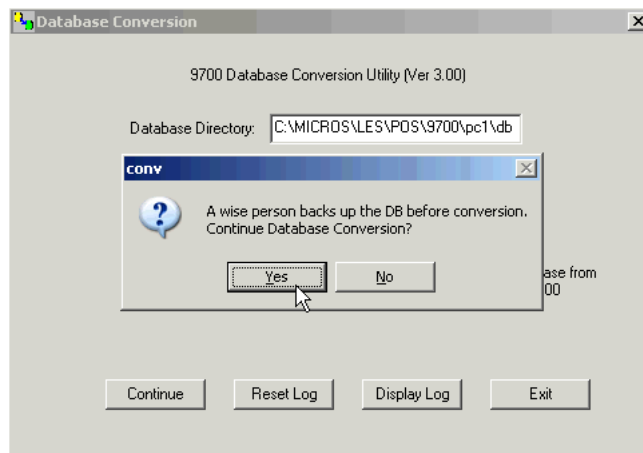

After you have backed up your system, click **Yes** to continue.

5. The Database Conversion commences, seen below...

```

C:\WINDOWS\system32\cmd.exe
nxt_ttl_set file: rvc2/rvc2.p4, L:\Conv150to170.cpp(414)l
Converted: rvc2/rvc2.p4, 12, 2608 Byte Records was 2480
nxt_ttl_set file: rvc2/rvc2.p5, L:\Conv150to170.cpp(414)l
Converted: rvc2/rvc2.p5, 13, 2608 Byte Records was 2480
nxt_ttl_set file: rvc2/rvc2.p6, L:\Conv150to170.cpp(414)l
Converted: rvc2/rvc2.p6, 14, 2608 Byte Records was 2480
Converted: rvc3/rvc3.cur, 15, 2608 Byte Records was 2480
nxt_ttl_set file: rvc3/rvc3.p1, L:\Conv150to170.cpp(414)l
Converted: rvc3/rvc3.p1, 16, 2608 Byte Records was 2480
nxt_ttl_set file: rvc3/rvc3.p2, L:\Conv150to170.cpp(414)l
Converted: rvc3/rvc3.p2, 17, 2608 Byte Records was 2480
nxt_ttl_set file: rvc3/rvc3.p3, L:\Conv150to170.cpp(414)l
Converted: rvc3/rvc3.p3, 18, 2608 Byte Records was 2480
nxt_ttl_set file: rvc3/rvc3.p4, L:\Conv150to170.cpp(414)l
Converted: rvc3/rvc3.p4, 19, 2608 Byte Records was 2480
nxt_ttl_set file: rvc3/rvc3.p5, L:\Conv150to170.cpp(414)l
Converted: rvc3/rvc3.p5, 20, 2608 Byte Records was 2480
nxt_ttl_set file: rvc3/rvc3.p6, L:\Conv150to170.cpp(414)l
Converted: rvc3/rvc3.p6, 21, 2608 Byte Records was 2480
Converted: rvc4/rvc4.cur, 22, 2608 Byte Records was 2480
nxt_ttl_set file: rvc4/rvc4.p1, L:\Conv150to170.cpp(414)l
Converted: rvc4/rvc4.p1, 23, 2608 Byte Records was 2480
nxt_ttl_set file: rvc4/rvc4.p2, L:\Conv150to170.cpp(414)l
Converted: rvc4/rvc4.p2, 24, 2608 Byte Records was 2480
  
```

6. After a few minutes, the Database Conversion finishes, and the Conversion confirmation window displays, seen below.

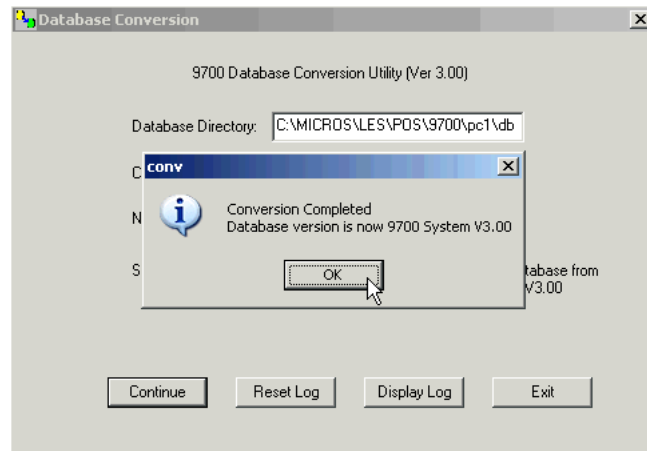

Click **OK**, then **Exit** to complete the Database Conversion.

Backup the System

After the software upgrade is complete, it is **strongly** recommended that you perform a full system backup, and store the backup in a safe and secure place.

After the system and database are backed up, proceed to “Upgrading MICROS Peripheral Applications” on page 3-63.

8700 —> 9700 V. 3.0 MS-SQL

If you are an existing UNIX-based 8700 System site, you must upgrade your database to 8700 Version 3.0, and prepare for MICROS Operational Resiliency as a backup scheme if desired, before transferring your database to a new Windows 2000/2003-based 9700 System. This preparation must be done on the existing UNIX-based system.

Before You Begin

Prior to any 9700 upgrade, you must perform the following tasks to ensure data integrity:

- Take a full backup of your system.
- Close all open guest checks.
- Run End-of-Day.
- Settle all credit card batches.
- Clear all guest checks.
- Reset the Audit Trail log.

Upgrade and Transfer Procedure

Before you begin the database transfer procedure, you must complete the following tasks in the order shown below:

- ◆ On the new *MICROS Server*, install Windows 2000 Server with Service Pack 4 or Windows 2003 Server.
- ◆ Install 9700 V. 3.0 on the Windows 2000/2003 Server
- ◆ Install the latest 9700 V. 3.0 Service Pack on the Windows 2000/2003 Server.
- ◆ Make sure Windows 2000 Server with Service Pack 4 or Windows 2003 Server, your network cards, and the 9700 System have been installed correctly on your Windows 2000/2003 Server.
- ◆ On the *UNIX Server*, upgrade your 8700 database to 8700 Version 3.0 using the database conversion utilities provided on your 9700 V. 3.0 System CD-ROM (refer to “Upgrade the 8700 Database” on page 3-26).
- ◆ Test that both the Windows 2000/2003 PC and the UNIX PC are available on the network, and that they can ping each other.
- ◆ Compress the 8700 V. 3.00 Database

- ◆ Transfer the compressed 8700 V. 3.00 Database to the 9700 V. 3.0 Server.
- ◆ On the 9700 V. 3.0 Server, convert the 8700 Version 3.0 database to a 9700 V. 3.0 database.

Note *If you are upgrading an EBUTO system and plan to use MICROS Operational Resiliency, you must upgrade the Primary PC first.*

*If you are upgrading a single PC, you **cannot** upgrade it to a MICROS Operational Resiliency system. The upgrade process can only upgrade similar system configurations (i.e., upgrade a single PC to a single PC).*

To upgrade a single PC system to a MICROS Operational Resiliency system, you must re-install the 9700 HMS software from scratch, and follow the prompts to configure a MICROS Operational Resiliency pair.

Upgrade the 8700 Database

The 9700 System installation CD provides a series of database conversion utilities to convert an 8700 database to Version 3.0. You must upgrade your 8700 database to Version 3.0 before it can be transferred to a 9700 System.

Note *If your system is already installed with 8700 Version 3.0, skip this section, and proceed to “Transfer the Database” on page 3-27.*

Before you begin the procedure below, make sure the Windows 2000/2003 PC and the UNIX PC are available on the network, and that they can ping each other.

Follow the steps below to upgrade your 8700 database to Version 3.0.

1. On the *UNIX Server*, perform a Micros Stop.
2. On the *Windows 2000/2003 Server*, insert the 9700 V. 3.0 CD into the PC's CD-ROM drive. If the CD automatically starts, simply cancel the installation process.
3. Through Windows Explorer, navigate to the CD-ROM drive. Right-click the CD-ROM drive, and Select Explore.
4. Copy the entire **Unix_DB_Conversion_UTILITY** folder to the C drive.

This folder contains all of the conversion utilities to convert any 8700 database up to a 3.0 database. You may not need all of these utilities, but it doesn't hurt to have all of them to ensure you have everything you need to convert to Version 3.0.

5. From the Windows Desktop, select *Start / Run*.
6. Type `cmd` and click **OK** to open a command prompt.
7. Change to the **C:\Unix_DB_Conversion_UTILITY** directory that you created in Step 4.
8. Type the following command:

```
ftp ip_address and press Enter.  
(where ip_address is the IP address of the UNIX PC)
```

-OR-

```
ftp name and press Enter.  
(where name is the UNIX PC name)
```

9. Type the root username and press **Enter**.

10. Type the password and press **Enter**.
11. Type `cd usr/8700/bin` and press **Enter**.
12. Type `bin` and press **Enter**.
13. Type `mput db*` and press **Enter**.
14. Type `y` and press **Enter**.
15. Type `mput conv*` and press **Enter**.

This command will start the transfer process of all of the database conversion utilities. Again, you may not need all of these utilities, but it doesn't hurt to transfer all of them.

16. Type `y` and press **Enter** each time you are prompted to transfer a conversion utility (e.g., `mput convert120?`, `mput convert150?`, `mput convert201?`, etc.).

When all of the conversion utilities are transferred, the `ftp>` prompt will display.

17. Type `quit` to end the transfer session. You are now ready to convert your database to 8700 Version 3.0.
18. On the *UNIX Server*, type the following at the UNIX command prompt:

```
mkdev m8700
```

and press **Enter**.

The *MICROS 8700 Maintenance and Installation Script* menu displays.

19. Type menu option 11 and press **Enter**.

Your database will convert to Version 3.0.

20. Proceed to *Transfer the Database* below.

Transfer the Database

Follow the steps below to transfer an 8700 Version 3.0 database to a 9700 database.

1. On the *UNIX Server*, login as root (the superuser).
2. At the command prompt, type:

```
ping -c2 computer_name
```

(where `computer_name` is the name of the UNIX PC.)
3. Record the IP address that is returned.

4. At the command prompt, type the following to switch to the m8700 user. Type
`su - m8700`
5. Change directories to *pc1*.
6. At the command prompt, create a *db.tar.Z* file in the *9700* directory by typing:
`tar cvf - db | compress > db.tar.Z`
7. On the *Windows 2000/2003 Server*, login as the administrator.
8. Open the Cygwin shell prompt from *Start / Programs / MICROS Systems 9700*.
9. Change directories to the *9700* directory by typing the following command:
`cd drive_letter\Micros\LES\Pos\9700\
(where drive_letter is the drive where the 9700 System is installed)`
10. Type the following command:
`ftp ip_address`
(where *ip_address* is the IP address of the UNIX PC identified in Step 2.)
11. Login with the root username and password.
12. Type the following command:
`cd /usr/8700/pc1`
13. Set the file transfer type to support binary image transfer by typing:
`bin`
14. Transfer the file to the *9700* directory of the *Windows 2000/2003 Server* by typing:
`get db.tar.Z`
15. When the transfer is complete, type:
`bye`

Note *As a precautionary measure on the Windows 2000/2003 server, rename your existing pc1 directory, as the decompression process will overwrite this directory.*

16. On the *Windows 2000/2003 Server*, open a Cygwin shell. From the *9700* directory, type the following command:
`zcat db.tar.Z | tar xvf -`

The files that are being uncompressed will scroll on the screen and a new *pc1* directory will be created.

Convert the 8700 Database to 9700

After you've transferred the 8700 3.0 database to the 9700, you need to convert it into a compatible 9700 database. Follow the steps below to convert the 9700 database.

Note Follow the steps in this section if you are:

*Upgrading a **single PC** system or upgrading the **Primary PC** in a MICROS Operational Resiliency system.*

If you are upgrading an EBUTO System to a MICROS Operational Resiliency System, the Secondary PC will retrieve the converted database from the Primary PC as part of the installation process.

Using the Database Conversion Utility

Because of the switch to an open database platform, the previous 9700 database cannot be used until the database conversion utility has been run. During the upgrade of the previous database to 9700 V. 3.0, the previous 8700 system configuration is preserved. To use the Database Conversion Utility, follow the instructions below:

1. Close all programs and return to Windows Desktop.
2. Go to the Windows Start Menu | Programs | MICROS Systems 9700 | Database Conversion, as seen below.

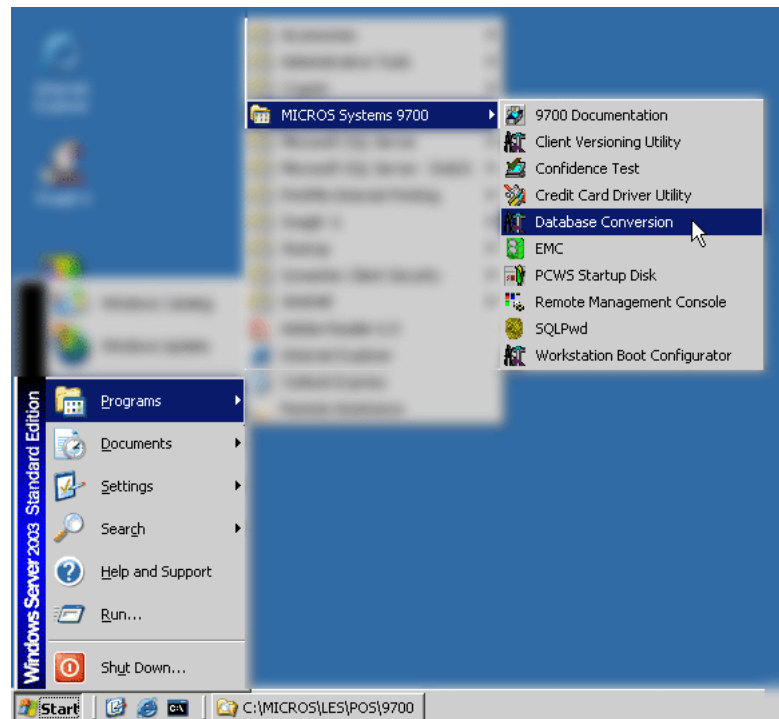

3. The Database Conversion Utility appears, seen below.

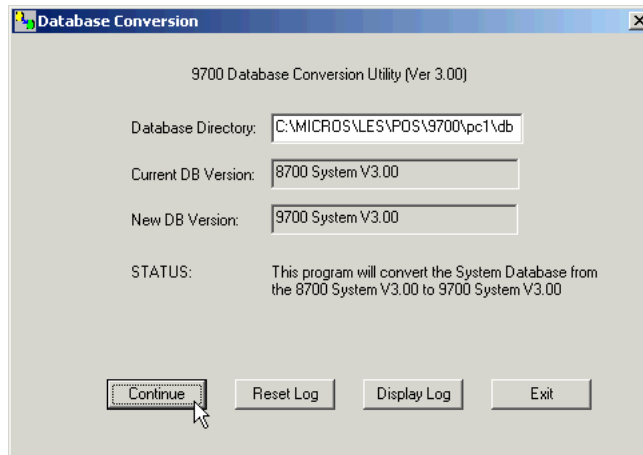

The Utility recognizes the previous database version (Current DB Version field), and indicates what version (New DB Version field) it will be upgraded to. Once you have reviewed these settings, Click **Continue** to begin the conversion process.

4. A Database Conversion message appears, seen below.

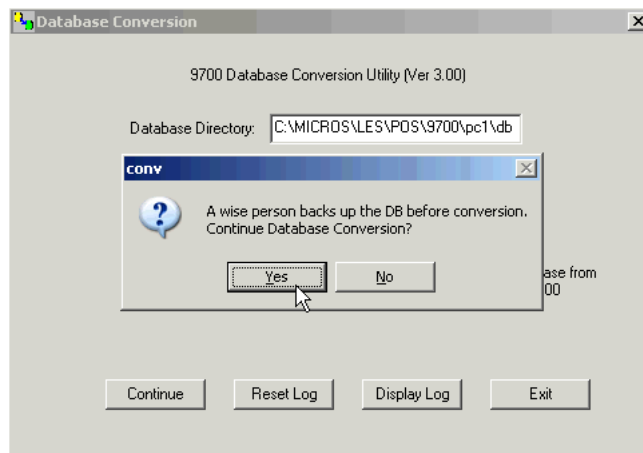

After you have backed up your system, click **Yes** to continue.

5. The Database Conversion commences, seen below...

```

C:\WINDOWS\system32\cmd.exe
nxt_ttl_set file: rvc2/rvc2.p4, I:\Conv150to170.cpp(414)l
Converted: rvc2/rvc2.p4, 12, 2608 Byte Records was 2480
nxt_ttl_set file: rvc2/rvc2.p5, I:\Conv150to170.cpp(414)l
Converted: rvc2/rvc2.p5, 13, 2608 Byte Records was 2480
nxt_ttl_set file: rvc2/rvc2.p6, I:\Conv150to170.cpp(414)l
Converted: rvc2/rvc2.p6, 14, 2608 Byte Records was 2480
Converted: rvc3/rvc3.cur, 15, 2608 Byte Records was 2480
nxt_ttl_set file: rvc3/rvc3.p1, I:\Conv150to170.cpp(414)l
Converted: rvc3/rvc3.p1, 16, 2608 Byte Records was 2480
nxt_ttl_set file: rvc3/rvc3.p2, I:\Conv150to170.cpp(414)l
Converted: rvc3/rvc3.p2, 17, 2608 Byte Records was 2480
nxt_ttl_set file: rvc3/rvc3.p3, I:\Conv150to170.cpp(414)l
Converted: rvc3/rvc3.p3, 18, 2608 Byte Records was 2480
nxt_ttl_set file: rvc3/rvc3.p4, I:\Conv150to170.cpp(414)l
Converted: rvc3/rvc3.p4, 19, 2608 Byte Records was 2480
nxt_ttl_set file: rvc3/rvc3.p5, I:\Conv150to170.cpp(414)l
Converted: rvc3/rvc3.p5, 20, 2608 Byte Records was 2480
nxt_ttl_set file: rvc3/rvc3.p6, I:\Conv150to170.cpp(414)l
Converted: rvc3/rvc3.p6, 21, 2608 Byte Records was 2480
Converted: rvc4/rvc4.cur, 22, 2608 Byte Records was 2480
nxt_ttl_set file: rvc4/rvc4.p1, I:\Conv150to170.cpp(414)l
Converted: rvc4/rvc4.p1, 23, 2608 Byte Records was 2480
nxt_ttl_set file: rvc4/rvc4.p2, I:\Conv150to170.cpp(414)l
Converted: rvc4/rvc4.p2, 24, 2608 Byte Records was 2480

```

6. After a few minutes, the Database Conversion finishes, and the Conversion confirmation window displays, seen below.

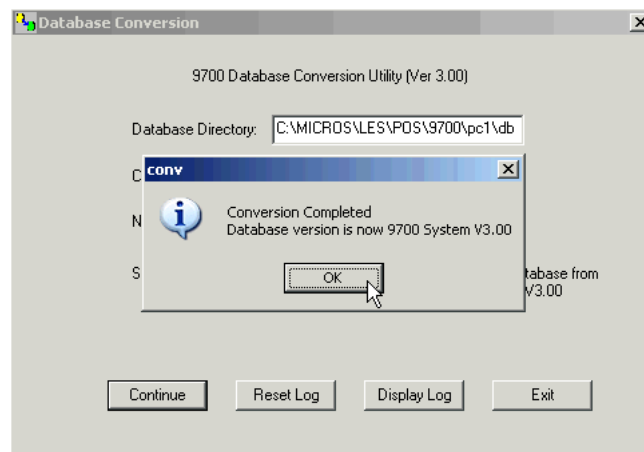

Click **OK**, then **Exit** to complete the Database Conversion.

Backup the System

After the software upgrade is complete, it is **strongly** recommended that you perform a full system backup, and store the backup in a safe and secure place.

Start the MICROS Services

After you've backed up the system, start up the MICROS services.

Follow the steps below to start the services.

1. On the 9700 server, from the Windows Desktop, select *Start / Settings / Control Panel / Administrative Tools*.
2. Double-click on **Services**.
3. Start the following Services:
 - ♦ MICROS 9700 POS
 - ♦ MICROS 9700 Multiplexer
 - ♦ MICROS 9700 Bootp/Tftp
4. Close the *Services* window. You have just completed the 9700 upgrade process!

Install the Remote Enterprise Management Console (Remote EMC) on the Clients

After you've completed the upgrade from 8700 to 9700, you're ready to install the *Remote Enterprise Management Console* on the clients in the system.

Refer to "Installing Remote Enterprise Management Console (Remote EMC)" on page 2-52 for installation instructions.

Oracle Upgrades

This section details the three scenarios of Oracle upgrades:

- ◆ For a detailed description of upgrading a previous version of 9700 to 9700 V. 3.00 using the *same* server, refer to:

“Previous Version of 9700 —> 9700 Version 3.0 Oracle, using existing 9700 Server” on page 3-34

- ◆ For a detailed description of upgrading a previous version of 9700 to 9700 V. 3.00 using a *different* server, refer to:

“Previous Version of 9700 —> 9700 Version 3.0 Oracle, using new 9700 Server” on page 3-46

- ◆ For a detailed description of upgrading an 8700 system to 9700 V. 3.00 using a *different* server, refer to:

“8700 —> 9700 Version 3.0 Oracle” on page 3-54

Note *Detailed instructions for upgrading MICROS peripheral applications, such as:*

*-Remote Management Console
-BootP Server
-WinStation Client*

Can be found at “Upgrading MICROS Peripheral Applications” on page 3-63.

Previous Version of 9700 — >

9700 Version 3.0 Oracle, using existing 9700 Server

Before you begin

Prior to any upgrade, you must perform the following tasks to ensure data integrity:

- Take a full backup of your system
- Close all open guest checks
- Run End-of-Day
- Settle all credit card batches
- Clear all guest checks
- Reset the audit trail log

The Upgrade Procedure

Follow the upgrade procedures in the order listed below.

- ◆ Shutdown the 9700 System from the 9700 Control Panel.
- ◆ Stop the MICROS services from the Windows Control Panel.
- ◆ Backup the system.
- ◆ Upgrade to Windows 2000 Server with SP4, or Windows 2003 Server—please refer to your Windows documentation for proper installation procedures.
- ◆ Install Oracle 9i. For detailed instructions, please see “Installing the Database Server” on page 2-11.
- ◆ Install 9700 Version 3.0 on the server.
- ◆ Install the latest 9700 V. 3.0 Service Pack from the MICROS Website.

- ◆ Backup the system.

Note *If you are upgrading an EBUTO system and plan to use MICROS Operational Resiliency, you must upgrade the Primary PC **first**.*

*If you are upgrading a single PC, you **cannot** upgrade it to a MICROS Operational Resiliency system. The upgrade process can only upgrade similar system configurations (i.e., upgrade a single PC to a single PC).*

To upgrade a single PC system to a MICROS Operational Resiliency system, you must re-install the 9700 HMS software from scratch, and follow the prompts to configure a MICROS Operational Resiliency pair.

Shutdown the 9700 System

Before you begin the upgrade, make sure the 9700 System is shutdown.

Follow the steps below to shutdown the 9700 System.

1. From the Windows Desktop, select *Start / Programs / MICROS Systems 9700 / Control Panel*

-OR-

Double-click on the **Control Panel** icon on your desktop.

2. Type a valid ID (password) and press **Enter**.
3. Click the **System** button, and then click **OK** to shutdown the system.
4. Proceed to *Stop the MICROS Services* below.

Stop the MICROS Services

Before you begin the upgrade, make sure the MICROS services are shut down.

Follow the steps below to stop the services.

1. On the 9700 server, from the Windows Desktop, select *Start / Settings / Control Panel / Administrative Tools*.
2. Double-click on **Services**.
3. Stop the following services:
 - ♦ MICROS 9700 POS
 - ♦ MICROS 9700 Multiplexer
 - ♦ MICROS 9700 Bootp/Tftp
4. Close the *Services* window.
5. Proceed to *Backup the System* below.

Backup the System

Before you begin the upgrade, it is **strongly** recommended that you perform a full system backup, and store the backup in a safe and secure place. As a safety precaution, also take a full backup of the pc1 folder.

Upgrading your Previous 9700 System to a 9700 V. 3.00 System with Oracle

After you have backed up the previous 9700 system and database, upgraded your operating system to Windows 2000 Server with SP4 or Windows 2003 Server, and installed Oracle 9i, you're ready to upgrade to 9700 Version 3.00. Please note that your existing database will be automatically upgraded during the installation process.

1. Close all programs and return to the *Windows Desktop*.
2. Insert the 9700 Version 3.0 CD into the PC's CD-ROM drive. The *9700 HMS* splash screen displays briefly...



...and then the main installation screen, the *Welcome to the InstallShield Wizard for 9700 HMS* screen displays, seen below.

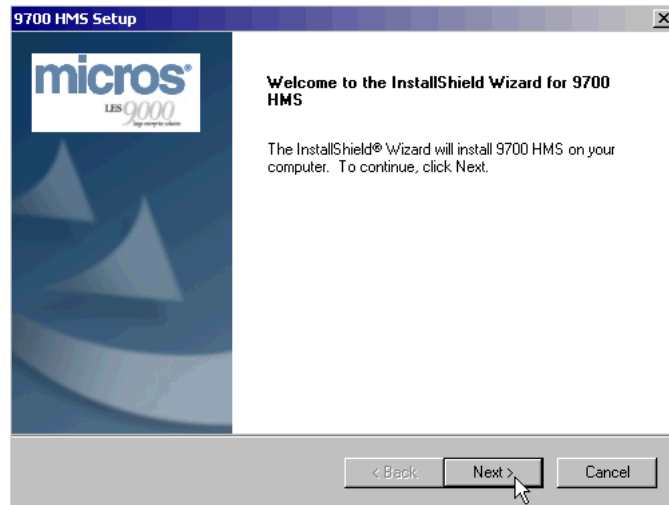

3. After reading the 9700 V. 3.0 System Setup documentation, click **Next** to continue the installation.
4. The *Select the Database Type* screen displays, seen below.

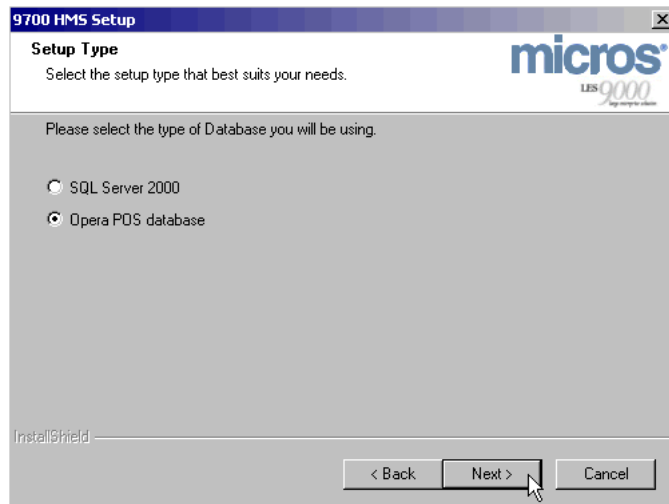

Select **Opera POS database**, then click **Next** to continue.

5. The *Database Information* screen displays, (Local Machine configuration shown) seen below. Configure the screen according to the installation parameters detailed below:

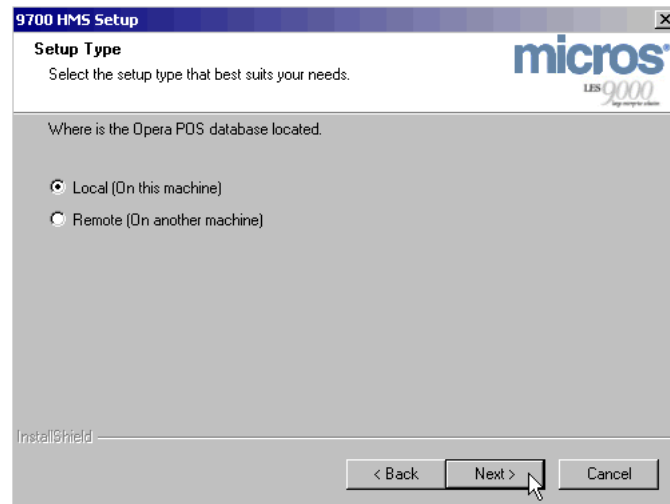

Select the Database Server Location

- ◆ **Local** - choose this option if you are installing 9700 Version 3.0 using a local instance of Oracle 9i, i.e., Oracle is located on the same server as 9700 V. 3.0
- ◆ **Remote** - choose this option if Oracle is *NOT* located on the server you are installing 9700 Version 3.0 on, i.e., a remote installation off of the site's network. Enter the computer name or the static IP address when prompted to identify the Oracle server on the network.

Once you have selected the Database Server location, click **Next** to continue.

6. The *Database Information* screen displays, seen below.

The screenshot shows a window titled "9700 HMS Setup" with a "Database Information" section. It prompts the user to enter information for the Opera POS database service. The service name "MCRSPOS" is entered in the first field. The user "system" and a masked password "*****" are entered in the subsequent fields. The "Next >" button is highlighted with a mouse cursor.

Select the OperaPOS database Service

Enter the Oracle Database Service Name. This is the database service name you will store MICROS data on. With a MICROS instance of Oracle this is MCRSPOS. Once you have decided the Database Service Name...

Enter OperaPOS database User and Password

Enter the User name and Password for a “user with create privileges”. With a MICROS instance of Oracle this is **system** and **system**. Once you have configured the User Name and Password for a “user with create privileges”, and the Opera POS Database Service, click **Next** to continue.

7. The *Opera POS Database User* screen displays, seen below.

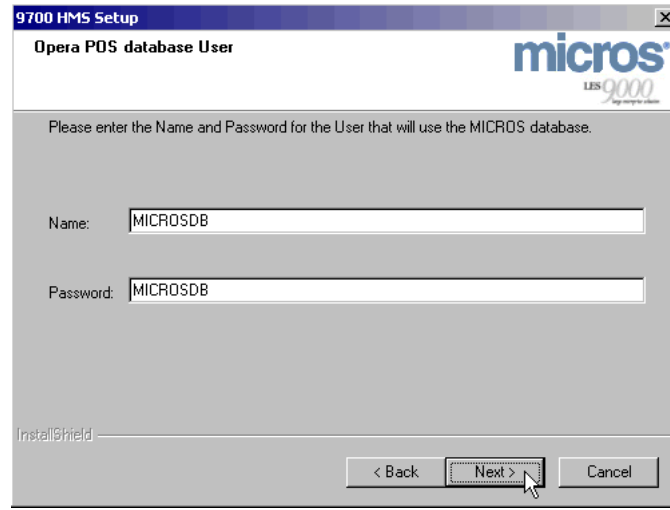

Enter the Name and Password of the User that will use the OperaPOS database. MICROS defaults are **MICROSDB** and **MICROSDB**. Once you have entered the Opera POS database User and Password, click **Next** to continue.

8. The *Tablespace Name* screen displays, seen below.

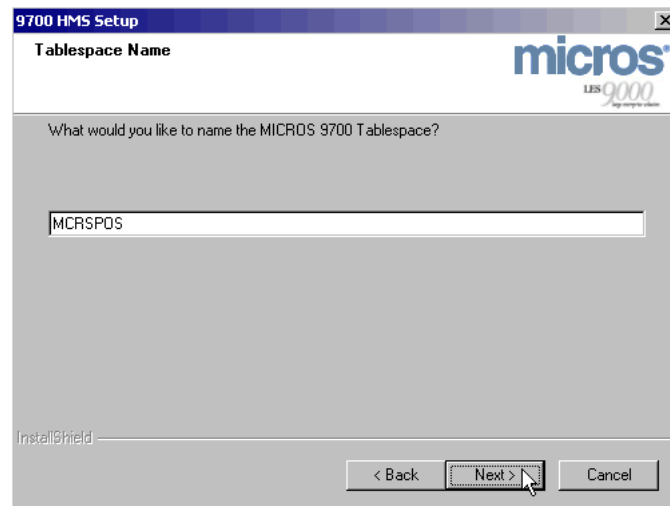

The default MICROS 9700 Tablespace is **MCRSPOS**. If you wish to change the name, type the new name into the field. Once you have decided the Tablespace Name, click **Next** to continue.

9. The *Opera POS Database File Location* screen displays, seen below. Select the Folder where you would like the Opera POS Database files to be saved.

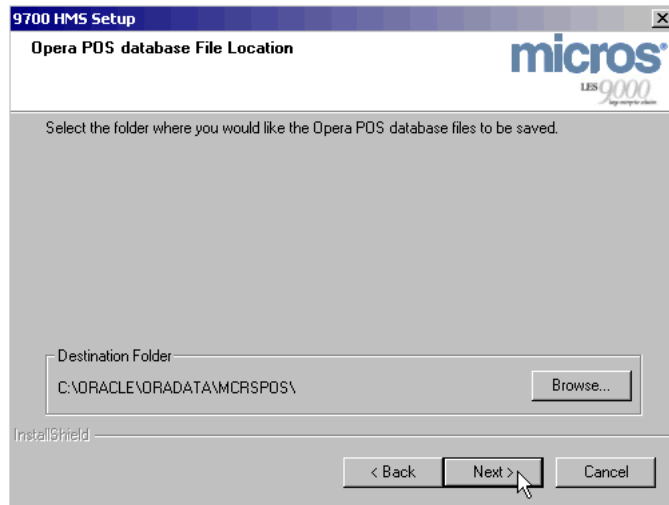

Accept the default location, or click **Browse** to select a different location. Once you have selected the Destination Folder, click **Next** to continue the installation.

10. The *9700 HMS Upgrade Installation Summary* screen displays, seen below.

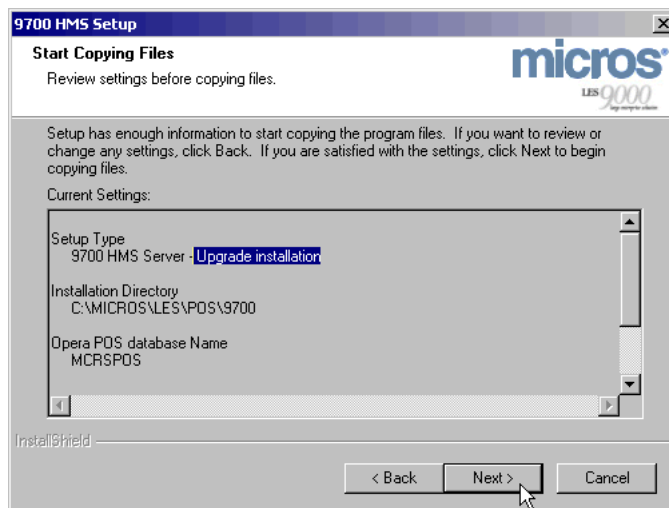

This screen provides a summary of all the parameters defined in the previous steps. Review these settings to make sure these are the correct installation parameters. Once you have verified these settings, click **Next** to continue the installation.

11. After you click **Next**, a 9700 HMS Setup Status message appears.

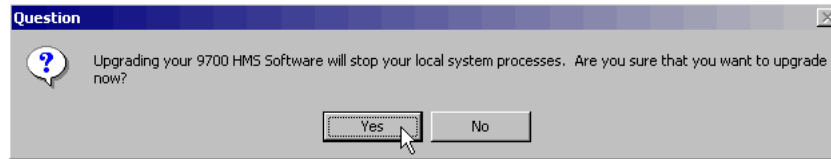

Once you have read the Note above, click **Yes** to continue the installation. If you do not wish to upgrade at this time, because it will stop your local system processes, click **No** to abort the installation.

Once you click **Yes**...

12. The installation starts. Status windows allow the user to monitor the progress of the installation. 9700 Version 3.0 first installs Cygwin, seen below...

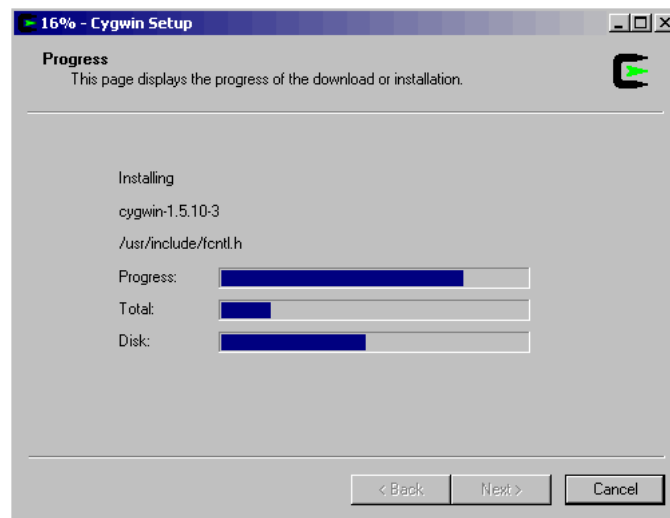

...Once the Cygwin installation completes, 9700 Version 3.00 begins installing the 9700 Server files, seen below...

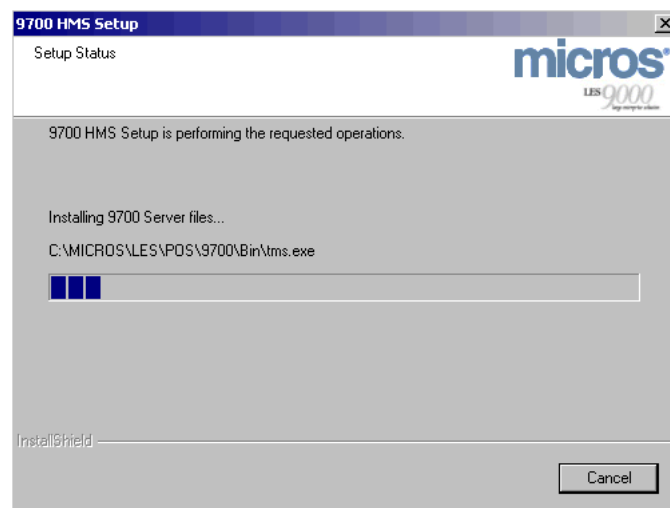

13. A 9700 HMS Setup Status message displays, seen below.

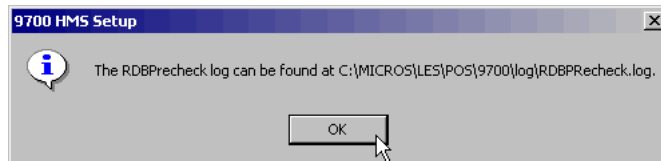

This message notifies the user of the location of the RDBPrecheck log. This log records modifications made to the pre-3.0 database. Some modifications may be necessary to ensure referential integrity for the 3.0 database. Click **Next** to continue.

14. A 9700 HMS Setup Status message displays, seen below.

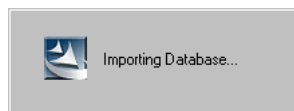

15. A status notification message displays, seen below.

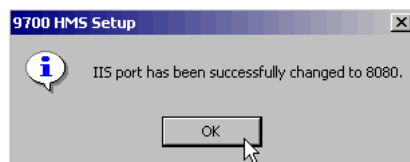

This message notifies the user that the IIS port has been changed to 8080. To continue the installation, click **OK**.

16. A status notification message displays, seen below.

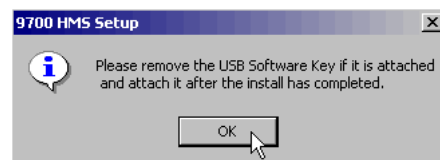

If there is a USB Software Key attached to the server, please remove it from the server now, and attach it after the installation has completed. Once you have removed the USB Software Key, if applicable, click **OK** to continue.

17. After a few moments, the *InstallShield Wizard Complete* screen displays, seen below.

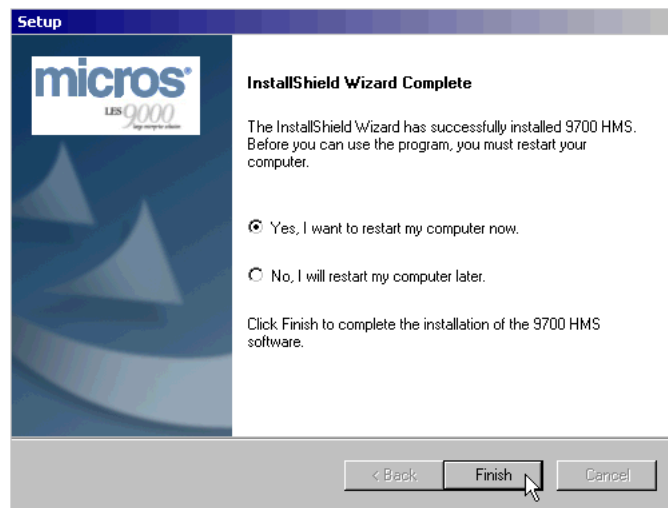

To complete the 9700 Version 3.0 upgrade installation, select **Yes, I want to restart my computer now.**, then click **Finish**.

Previous Version of 9700 — >

9700 Version 3.0 Oracle, using new 9700 Server

Before you begin

Prior to any 9700 upgrade, you must perform the following tasks to ensure data integrity:

- Take a full backup of your system.
- Close all open guest checks.
- Run End-of-Day.
- Settle all credit card batches.
- Clear all guest checks.
- Reset the Audit Trail log.

The Upgrade Procedure

Follow the upgrade procedures in the order listed below.

- ◆ On the New Server, install Windows 2000 Server with SP4 or Windows 2003 Server. Please refer to your Windows documentation for proper installation procedure.
- ◆ On the New Server, install Oracle 9i (the database server does not *need* to be installed locally, but *must* be available on the network)
- ◆ On the New Server, install 9700 V. 3.00
- ◆ On the New Server, install the latest 9700 V. 3.00 Service Pack.
- ◆ On the Old Server, shutdown the 9700 System from the 9700 Control Panel.
- ◆ On the Old Server, stop the MICROS services from the Windows Control Panel.
- ◆ Backup both systems
- ◆ Make sure both PC's are on the Network.
- ◆ On the Old Server, Copy the pc1 directory to the \MICROS\LES\POS\9700 directory of the new server. You can do this by ftp, or since both PC's are on the network, by a direct copy and paste.

- ◆ On the New Server, run the Database Conversion Utility.

Note *If you are upgrading an EBUTO system and plan to use MICROS Operational Resiliency, you must upgrade the Primary PC **first**.*

*If you are upgrading a single PC, you **cannot** upgrade it to a MICROS Operational Resiliency system. The upgrade process can only upgrade similar system configurations (i.e., upgrade a single PC to a single PC).*

To upgrade a single PC system to a MICROS Operational Resiliency system, you must re-install the 9700 HMS software from scratch, and follow the prompts to configure a MICROS Operational Resiliency pair.

Shutdown the 9700 System

Before you begin the upgrade, make sure the 9700 System is shutdown.

Follow the steps below to shutdown the 9700 System.

1. From the Windows Desktop, select *Start / Programs / MICROS Systems 9700 / Control Panel*.

-OR-

Double-click on the **Control Panel** icon on your desktop.

2. Type a valid ID (password) and press **Enter**.
3. Click the **System** button, and then click **OK** to shutdown the system.
4. Proceed to *Stop the MICROS Services* below.

Stop the MICROS Services

Before you begin the upgrade, make sure the MICROS Services are shut down.

Follow the steps below to stop the services.

1. On the 9700 Server, from the Windows desktop, select *Start / Settings / Control Panel / Administrative Tools*.
2. Double-click on **Services**.
3. Stop the following services:
 - ♦ MICROS 9700 POS
 - ♦ MICROS 9700 Multiplexer
 - ♦ MICROS 9700 BootP/Tftp
4. Close the *Services* window.
5. Proceed to *Backup the System* below.

Backup the System

Before you begin the upgrade, it is **strongly** recommended that you perform a full system backup, and store the backup in a safe and secure place. As a safety precaution, take a full backup of the pc1 folder.

Decompressing the Previous 9700 Database

Before you run the MICROS Database Conversion Utility, the previous database must be on the 9700 V. 3.00 server, and decompressed (if appropriate) from the tar.Z format. To decompress the previous 9700 database, follow the steps listed below:

Note *If you have already decompressed your previous 9700 database, or elected to directly copy the pc1 directory over the network, please proceed to “Using the Database Conversion Utility” on page 3-51.*

1. Close all programs and return to the Windows Desktop.
2. On the 9700 V. 3.0 server, navigate to \MICROS\LES\POS\9700, seen below. Make sure the database from the previous 9700 system is located here (seen below). As a safety precaution, rename the existing pc1 directory (seen below).

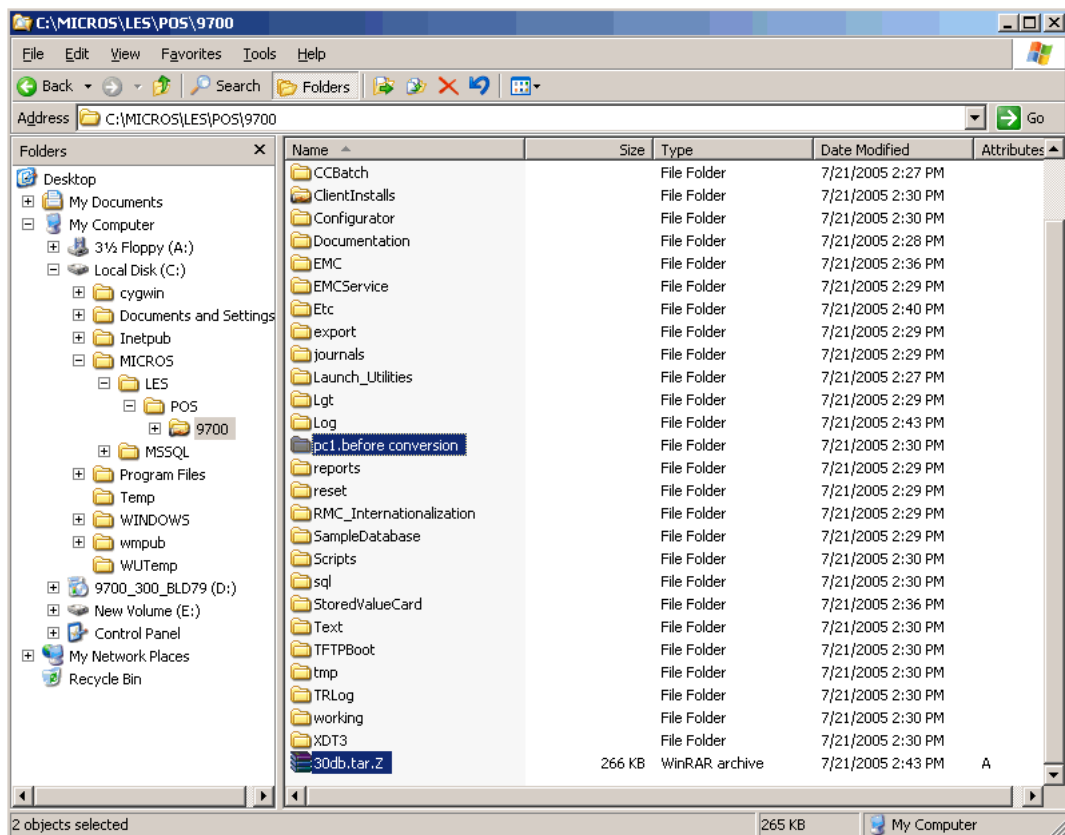

3. Once you have verified the previous 9700 database file is present, and you have renamed the previous pc1 directory, open a Cygwin shell prompt.

- Once in the \MICROS\LES\POS\9700 directory, decompress the previous 9700 database using the Cygwin shell prompt, as seen below.

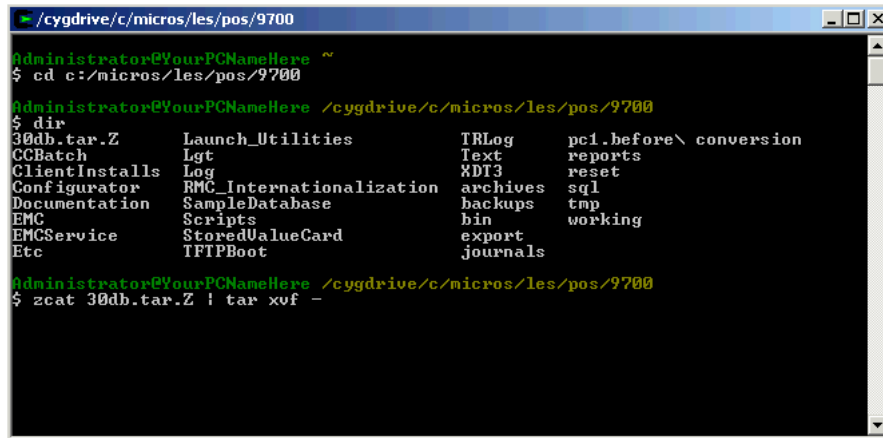

```
Administrator@YourPCNameHere ~
$ cd c:/micros/les/pos/9700
Administrator@YourPCNameHere /cygdrive/c/micros/les/pos/9700
$ dir
30db.tar.Z      Launch_Utilities      TRLog      pc1.before\ conversion
CCBatch        Lgt                  Text       reports
ClientInstalls Log                  XDT3       reset
Configurator   RMC_Internationalization archives    sql
Documentation   SampleDatabase      backups    tmp
EMC            Scripts              bin        working
EMCSERVICE     StoredValueCard     export
Etc            TFTPBoot            journals

Administrator@YourPCNameHere /cygdrive/c/micros/les/pos/9700
$ zcat 30db.tar.Z | tar xvf -
```

To decompress the previous 9700 database, enter the UNIX command, **zcat filename | tar xvf -** (where filename = database name), then press **Enter**.

- The file decompression process begins...After a few moments, the decompression process completes, and you will be returned to the “\$” prompt.

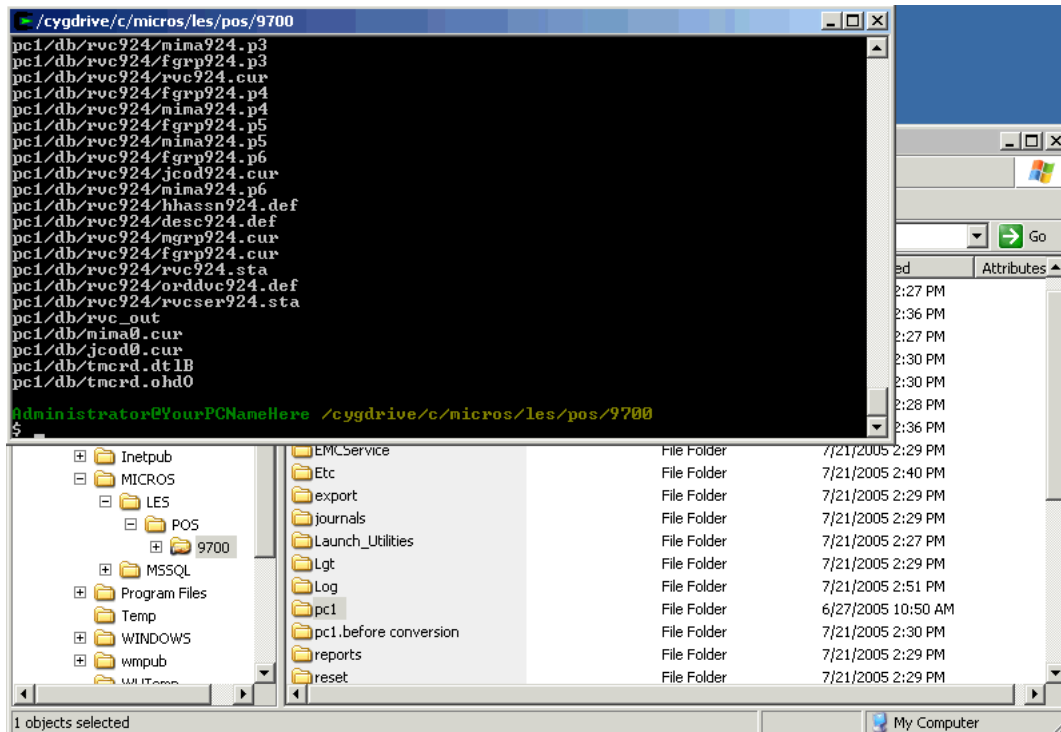

Please note that this process creates a new pc1 directory.

- Once you have decompressed the previous 9700 database, continue to “Using the Database Conversion Utility”.

Using the Database Conversion Utility

Because of the switch to an open database platform, the previous 9700 database cannot be used until the database conversion utility has been run. During the upgrade of the previous database to 9700 V. 3.0, the previous 9700 system configuration is preserved. To use the Database Conversion Utility, follow the instructions below:

1. Close all programs and return to Windows Desktop.
2. Go to the Windows Start Menu | Programs | MICROS Systems 9700 | Database Conversion, as seen below.

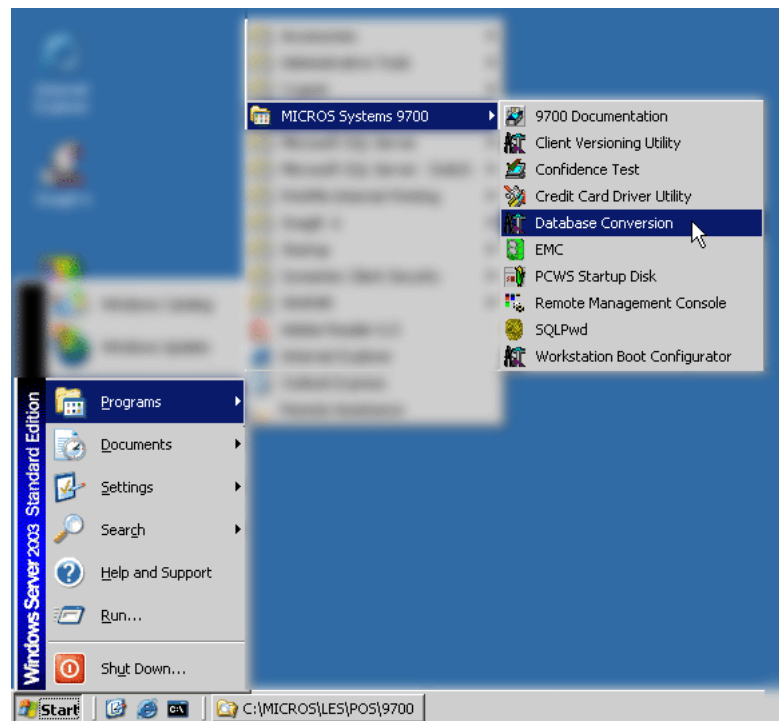

3. The Database Conversion Utility appears, seen below.

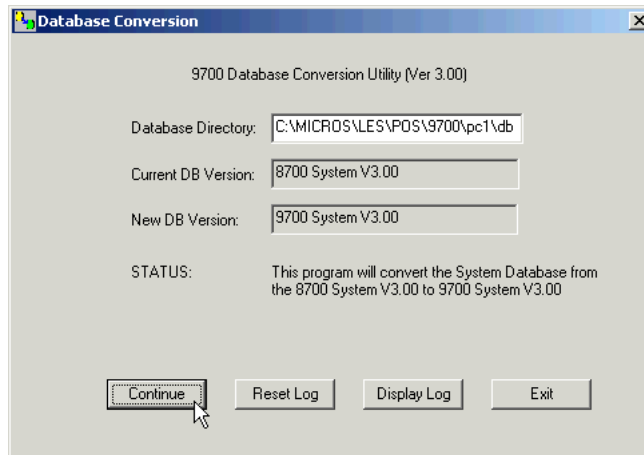

The Utility recognizes the previous database version (Current DB Version field), and indicates what version (New DB Version field) it will be upgraded to. Once you have reviewed these settings, Click **Continue** to begin the conversion process.

4. A Database Conversion message appears, seen below.

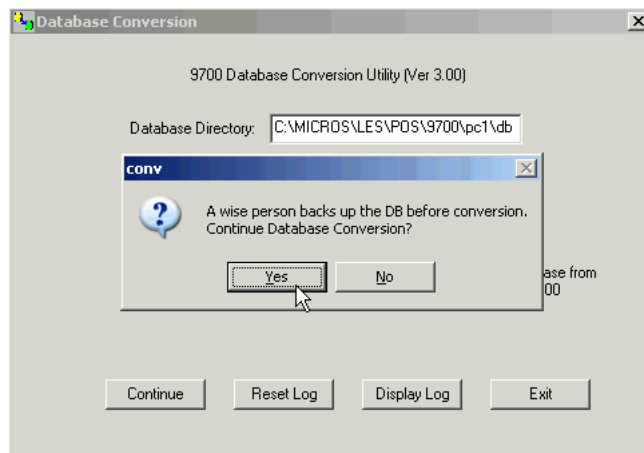

After you have backed up your system, click **Yes** to continue.

5. The Database Conversion commences, seen below...

```

C:\WINDOWS\system32\cmd.exe
nxt_ttl_set file: rvc2/rvc2.p4, I:\Conv150to170.cpp(414)l
Converted: rvc2/rvc2.p4, 12, 2608 Byte Records was 2480
nxt_ttl_set file: rvc2/rvc2.p5, I:\Conv150to170.cpp(414)l
Converted: rvc2/rvc2.p5, 13, 2608 Byte Records was 2480
nxt_ttl_set file: rvc2/rvc2.p6, I:\Conv150to170.cpp(414)l
Converted: rvc2/rvc2.p6, 14, 2608 Byte Records was 2480
Converted: rvc3/rvc3.cur, 15, 2608 Byte Records was 2480
nxt_ttl_set file: rvc3/rvc3.p1, I:\Conv150to170.cpp(414)l
Converted: rvc3/rvc3.p1, 16, 2608 Byte Records was 2480
nxt_ttl_set file: rvc3/rvc3.p2, I:\Conv150to170.cpp(414)l
Converted: rvc3/rvc3.p2, 17, 2608 Byte Records was 2480
nxt_ttl_set file: rvc3/rvc3.p3, I:\Conv150to170.cpp(414)l
Converted: rvc3/rvc3.p3, 18, 2608 Byte Records was 2480
nxt_ttl_set file: rvc3/rvc3.p4, I:\Conv150to170.cpp(414)l
Converted: rvc3/rvc3.p4, 19, 2608 Byte Records was 2480
nxt_ttl_set file: rvc3/rvc3.p5, I:\Conv150to170.cpp(414)l
Converted: rvc3/rvc3.p5, 20, 2608 Byte Records was 2480
nxt_ttl_set file: rvc3/rvc3.p6, I:\Conv150to170.cpp(414)l
Converted: rvc3/rvc3.p6, 21, 2608 Byte Records was 2480
Converted: rvc4/rvc4.cur, 22, 2608 Byte Records was 2480
nxt_ttl_set file: rvc4/rvc4.p1, I:\Conv150to170.cpp(414)l
Converted: rvc4/rvc4.p1, 23, 2608 Byte Records was 2480
nxt_ttl_set file: rvc4/rvc4.p2, I:\Conv150to170.cpp(414)l
Converted: rvc4/rvc4.p2, 24, 2608 Byte Records was 2480
    
```

6. After a few minutes, the Database Conversion finishes, and the Conversion confirmation window displays, seen below.

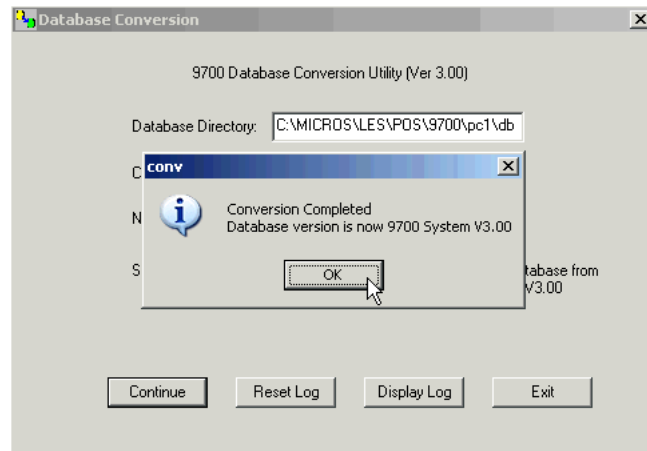

Click **OK**, then **Exit** to complete the Database Conversion.

8700 —> 9700 Version 3.0 Oracle

If you are an existing UNIX-based 8700 System site, you must upgrade your database to 8700 Version 3.0, and prepare for MICROS Operational Resiliency as a backup scheme if desired, prior to transferring your database to a new Windows 2000/2003 based 9700 System. This preparation must be done on the existing UNIX-based system.

Before you Begin

Prior to any 9700 upgrade, you must perform the following tasks to ensure data integrity:

- Take a full backup of your system.
- Close all open guest checks.
- Run End-of-Day.
- Settle all credit card batches.
- Clear all guest checks.
- Reset the Audit Trail log.

Upgrade and Transfer Procedure

Before you begin the database transfer procedure, you must complete the following tasks in the order shown below

- ◆ On the new MICROS Server, install Windows 2000 Server with SP4 or Windows 2003.
- ◆ Install 9700 V. 3.0 on the Windows 2000/2003 Server.
- ◆ Install the latest 9700 V. 3.0 Service Pack on the Windows 2000/2003.
- ◆ Make sure Windows 2000 Server with SP4 or Windows 2003 Server, your network cards, and the 9700 System have been installed correctly on your Windows 2000/2003 server.
- ◆ On the UNIX Server, upgrade your 8700 database to 8700 Version 3.0 using the database conversion utilities provided on your 9700 V. 3.0 System CD-ROM.
- ◆ Test that both the Windows 2000/2003 PC and the UNIX PC are available on the network, and that they can ping each other.
- ◆ Compress the 8700 V. 3.0 Database.

- ◆ Transfer the compressed 8700 V. 3.00 Database to the 9700 V. 3.00 Server.
- ◆ On the 9700 V. 3.0 Server, convert the 8700 Version 3.00 Database to a 9700 V. 3.00 database.

Note *If you are upgrading an EBUTO system and plan to use MICROS Operational Resiliency, you must upgrade the Primary PC first.*

*If you are upgrading a single PC, you **cannot** upgrade it to a MICROS Operational Resiliency system. The upgrade process can only upgrade similar system configurations (i.e., upgrade a single PC to a single PC).*

To upgrade a single PC system to a MICROS Operational Resiliency system, you must re-install the 9700 HMS software from scratch, and follow the prompts to configure a MICROS Operational Resiliency pair.

Upgrade the 8700 Database

The 9700 System installation CD provides a series of database conversion utilities to convert an 8700 database to Version 3.0. You must upgrade your 8700 database to Version 3.0 before it can be transferred to a 9700 System.

***Note** If your system is already installed with 8700 Version 3.0, skip this section, and proceed to Transfer the Database on page 3-57.*

Before you begin the procedure below, make sure the Windows 2000/2003 PC and the UNIX PC are available on the network, and that they can ping each other.

Follow the steps below to upgrade your 8700 database to Version 3.0.

1. On the *UNIX Server*, perform a Micros Stop.
2. On the *Windows 2000/2003 Server*, insert the 9700 V. 3.0 CD into the PC's CD-ROM drive. If the CD automatically starts, simply cancel the installation process.
3. Through Windows Explorer, navigate to the CD-ROM drive. Right-click the CD-ROM drive, and Select Explore.
4. Copy the entire **Unix_DB_Conversion_UTILITY** folder to the C drive.

This folder contains all of the conversion utilities to convert any 8700 database up to a 3.0 database. You may not need all of these utilities, but it doesn't hurt to have all of them to ensure you have everything you need to convert to Version 3.0.

5. From the Windows Desktop, select *Start / Run*.
6. Type `cmd` and click **OK** to open a command prompt.
7. Change to the **C:\Unix_DB_Conversion_UTILITY** directory that you created in Step 4.
8. Type the following command:

```
ftp ip_address and press Enter.  
(where ip_address is the IP address of the UNIX PC)
```

-OR-

```
ftp name and press Enter.  
(where name is the UNIX PC name)
```

9. Type the root username and press **Enter**.

10. Type the password and press **Enter**.
11. Type `cd usr/8700/bin` and press **Enter**.
12. Type `bin` and press **Enter**.
13. Type `mput db*` and press **Enter**.
14. Type `y` and press **Enter**.
15. Type `mput conv*` and press **Enter**.

This command will start the transfer process of all of the database conversion utilities. Again, you may not need all of these utilities, but it doesn't hurt to transfer all of them.

16. Type `y` and press **Enter** each time you are prompted to transfer a conversion utility (e.g., `mput convert120?`, `mput convert150?`, `mput convert201?`, etc.).

When all of the conversion utilities are transferred, the `ftp>` prompt will display.

17. Type `quit` to end the transfer session. You are now ready to convert your database to 8700 Version 3.0.
18. On the *UNIX Server*, type the following at the UNIX command prompt:

```
mkdev m8700
```

and press **Enter**.

The *MICROS 8700 Maintenance and Installation Script* menu displays.

19. Type menu option 11 and press **Enter**.

Your database will convert to Version 3.0.

20. Proceed to *Transfer the Database* below.

Transfer the Database

Follow the steps below to transfer an 8700 Version 3.0 database to a 9700 database.

1. On the *UNIX Server*, login as root (the superuser).
2. At the command prompt, type:

```
ping -c2 computer_name
```

(where `computer_name` is the name of the UNIX PC.)
3. Record the IP address that is returned.

4. At the command prompt, type the following to switch to the m8700 user. Type
`su - m8700`
5. Change directories to *pc1*.
6. At the command prompt, create a *db.tar.Z* file in the *9700* directory by typing:
`tar cvf - db | compress > db.tar.Z`
7. On the *Windows 2000/2003 Server*, login as the administrator.
8. Open the Cygwin shell prompt from *Start / Programs / MICROS Systems 9700*.
9. Change directories to the *9700* directory by typing the following command:
`cd drive_letter\Micros\LES\Pos\9700\
(where drive_letter is the drive where the 9700 System is installed)`
10. Type the following command:
`ftp ip_address
(where ip_address is the IP address of the UNIX PC identified in Step 2.)`
11. Login with the root username and password.
12. Type the following command:
`cd /usr/8700/pc1`
13. Set the file transfer type to support binary image transfer by typing:
`bin`
14. Transfer the file to the *9700* directory of the *Windows 2000/2003 Server* by typing:
`get db.tar.Z`
15. When the transfer is complete, type:
`bye`

Note *As a precautionary measure on the Windows 2000/2003 server, rename your existing pc1 directory, as the decompression process will overwrite this directory.*

16. On the *Windows 2000/2003 Server*, open a Cygwin shell. From the *9700* directory, type the following command:
`zcat db.tar.Z | tar xvf -`

The files that are being uncompressed will scroll on the screen and a new *pc1* directory will be created.

Convert the 8700 Database to 9700

After you've transferred the 8700 3.0 database to the 9700, you need to convert it into a compatible 9700 database. Follow the steps below to convert the 9700 database.

Note Follow the steps in this section if you are:

*Upgrading a **single PC** system or upgrading the **Primary PC** in an EBUTO system.*

If you are upgrading an EBUTO system, the Secondary PC will retrieve the converted database from the Primary PC as part of the installation process.

Using the Database Conversion Utility

Because of the switch to an open database platform, the previous 9700 database cannot be used until the database conversion utility has been run. During the upgrade of the previous database to 9700 V. 3.0, the previous 8700 system configuration is preserved. To use the Database Conversion Utility, follow the instructions below:

1. Close all programs and return to Windows Desktop.
2. Go to the Windows Start Menu | Programs | MICROS Systems 9700 | Database Conversion, as seen below.

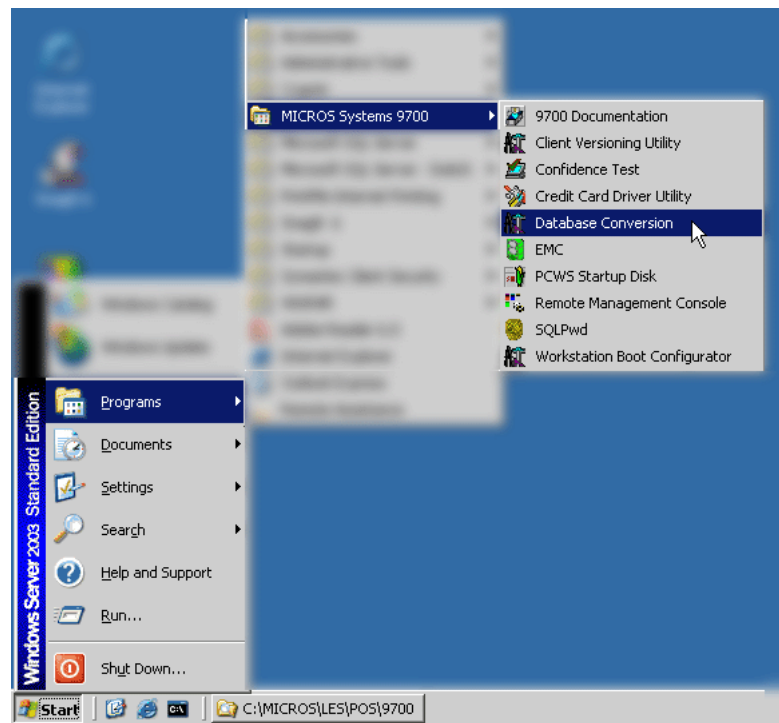

3. The Database Conversion Utility appears, seen below.

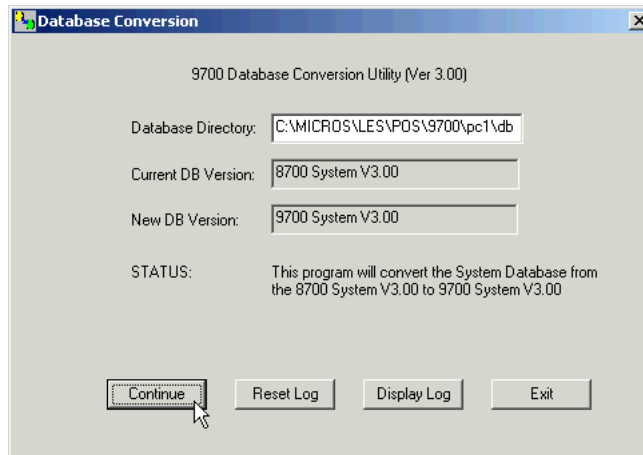

The Utility recognizes the previous database version (Current DB Version field), and indicates what version (New DB Version field) it will be upgraded to. Once you have reviewed these settings, Click **Continue** to begin the conversion process.

4. A Database Conversion message appears, seen below.

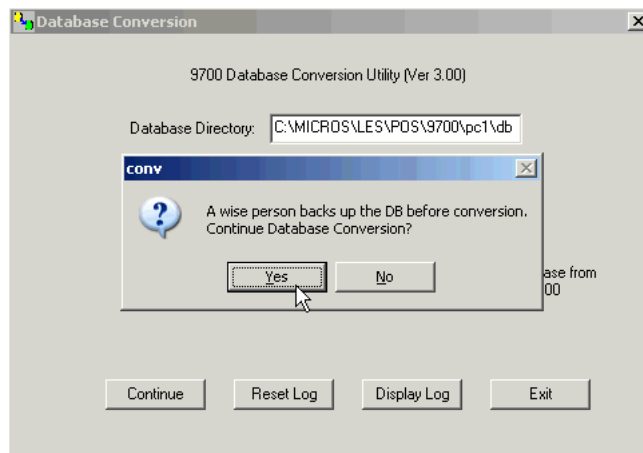

After you have backed up your system, click **Yes** to continue.

5. The Database Conversion commences, seen below...

```

C:\WINDOWS\system32\cmd.exe
nxt_ttl_set file: rvc2/rvc2.p4, I:\Conv150to170.cpp(414)l
Converted: rvc2/rvc2.p4, 12, 2608 Byte Records was 2480
nxt_ttl_set file: rvc2/rvc2.p5, I:\Conv150to170.cpp(414)l
Converted: rvc2/rvc2.p5, 13, 2608 Byte Records was 2480
nxt_ttl_set file: rvc2/rvc2.p6, I:\Conv150to170.cpp(414)l
Converted: rvc2/rvc2.p6, 14, 2608 Byte Records was 2480
Converted: rvc3/rvc3.cur, 15, 2608 Byte Records was 2480
nxt_ttl_set file: rvc3/rvc3.p1, I:\Conv150to170.cpp(414)l
Converted: rvc3/rvc3.p1, 16, 2608 Byte Records was 2480
nxt_ttl_set file: rvc3/rvc3.p2, I:\Conv150to170.cpp(414)l
Converted: rvc3/rvc3.p2, 17, 2608 Byte Records was 2480
nxt_ttl_set file: rvc3/rvc3.p3, I:\Conv150to170.cpp(414)l
Converted: rvc3/rvc3.p3, 18, 2608 Byte Records was 2480
nxt_ttl_set file: rvc3/rvc3.p4, I:\Conv150to170.cpp(414)l
Converted: rvc3/rvc3.p4, 19, 2608 Byte Records was 2480
nxt_ttl_set file: rvc3/rvc3.p5, I:\Conv150to170.cpp(414)l
Converted: rvc3/rvc3.p5, 20, 2608 Byte Records was 2480
nxt_ttl_set file: rvc3/rvc3.p6, I:\Conv150to170.cpp(414)l
Converted: rvc3/rvc3.p6, 21, 2608 Byte Records was 2480
Converted: rvc4/rvc4.cur, 22, 2608 Byte Records was 2480
nxt_ttl_set file: rvc4/rvc4.p1, I:\Conv150to170.cpp(414)l
Converted: rvc4/rvc4.p1, 23, 2608 Byte Records was 2480
nxt_ttl_set file: rvc4/rvc4.p2, I:\Conv150to170.cpp(414)l
Converted: rvc4/rvc4.p2, 24, 2608 Byte Records was 2480
    
```

6. After a few minutes, the Database Conversion finishes, and the Conversion confirmation window displays, seen below.

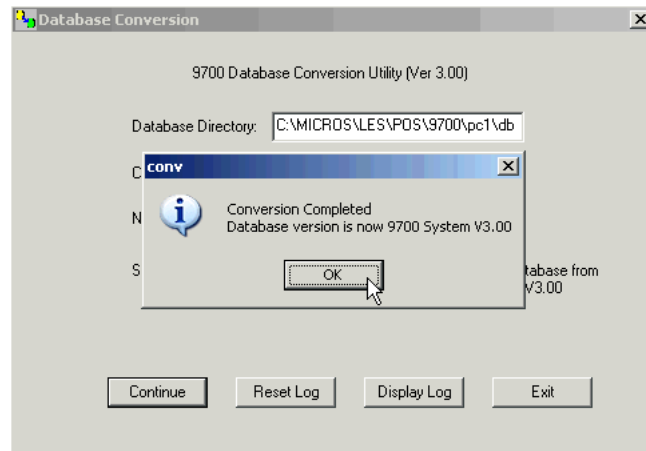

Click **OK**, then **Exit** to complete the Database Conversion.

Backup the System

After the software upgrade is complete, it is **strongly** recommended that you perform a full system backup, and store the backup in a safe and secure place.

Start the MICROS Services

After you've backed up the system, start up the MICROS services.

Follow the steps below to start the services.

1. On the 9700 server, from the Windows Desktop, select *Start / Settings / Control Panel / Administrative Tools*.
2. Double-click on **Services**.
3. Start the following services:
 - ♦ MICROS 9700 POS
 - ♦ MICROS 9700 Multiplexer
 - ♦ MICROS 9700 Bootp/Tftp
4. Close the *Services* window.

Upgrading MICROS Peripheral Applications

- ◆ Upgrade the Bootp Service (page 3-64).
- ◆ Upgrade the 9700 Remote Management Console on the clients (page 3-69).
- ◆ Upgrade the WinStation Client Application (page 3-73).

Note *To install the Remote Enterprise Management Console, please follow the directions on 2-52.*

Upgrade the Bootp Service

If you previously installed the Bootp Service, you need to upgrade it now.

Follow the steps below to upgrade Bootp.

1. Close all programs and return to the Windows Desktop.
2. On the BootP server, insert the 9700 System CD into the PC's CD-ROM drive. The CD automatically starts, and the *9700 HMS* splash screen briefly displays...



...and then the main installation screen, the *Welcome to the InstallShield Wizard for 9700 HMS* screen displays, seen below.

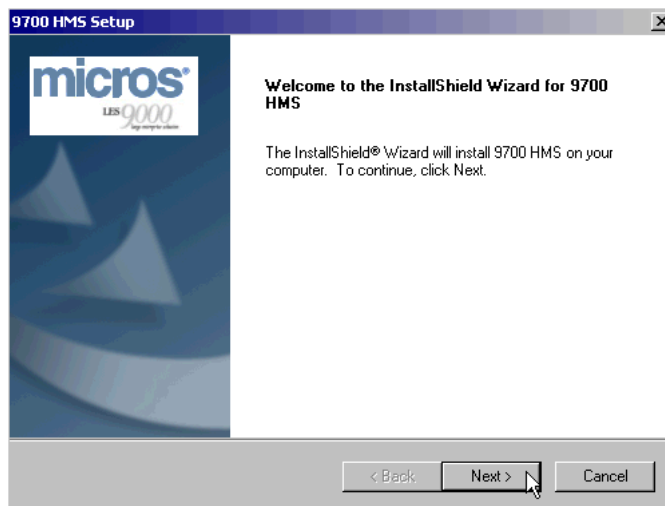

3. After reading the 9700 V. 3.0 System Setup documentation, click **Next** to continue the installation.
4. The *Customer Information* screen displays, seen below. Enter the User Name and Company Name, and click **Next** to continue the installation.

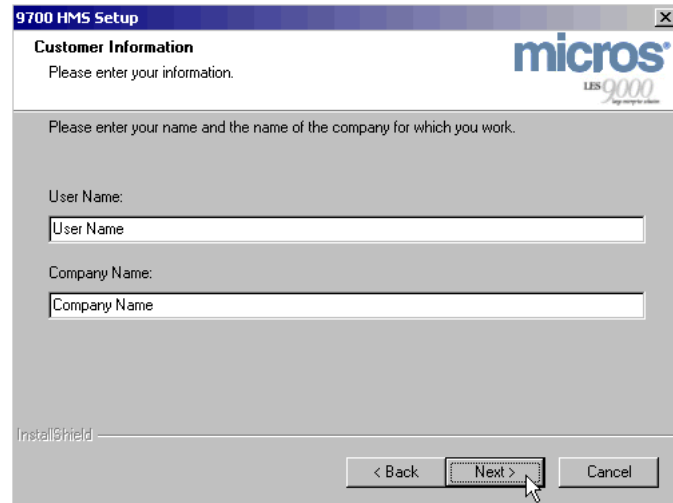

The screenshot shows the '9700 HMS Setup' window with the 'Customer Information' tab selected. The window title is '9700 HMS Setup'. The main heading is 'Customer Information' with the subtext 'Please enter your information.' and the 'micros' logo with 'US 9000' below it. Below this, it says 'Please enter your name and the name of the company for which you work.' There are two text input fields: 'User Name:' and 'Company Name:'. At the bottom, there are three buttons: '< Back', 'Next >', and 'Cancel'. A mouse cursor is pointing at the 'Next >' button.

5. The *Component Selection* screen displays. This screen allows a user to configure what elements of the 9700 V. 3.0 software are installed during this installation session.

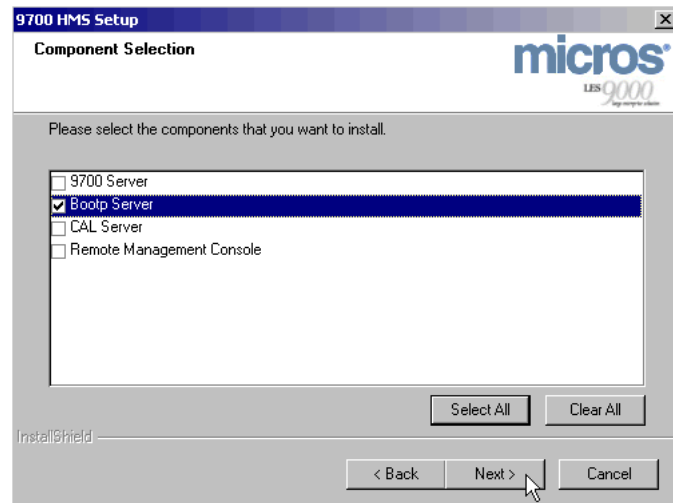

The screenshot shows the '9700 HMS Setup' window with the 'Component Selection' tab selected. The window title is '9700 HMS Setup'. The main heading is 'Component Selection' with the subtext 'Please select the components that you want to install.' and the 'micros' logo with 'US 9000' below it. Below this, there is a list of components with checkboxes: '9700 Server', 'Bootp Server' (checked), 'CAL Server', and 'Remote Management Console'. At the bottom, there are two buttons: 'Select All' and 'Clear All'. Below these, there are three buttons: '< Back', 'Next >', and 'Cancel'. A mouse cursor is pointing at the 'Next >' button.

To upgrade the BootP Server, configure this screen as seen above. Once you have done this, click **Next** to continue.

6. The *Installation Drive Selection* screen displays, seen below. Select the drive to install the BootP Server on.

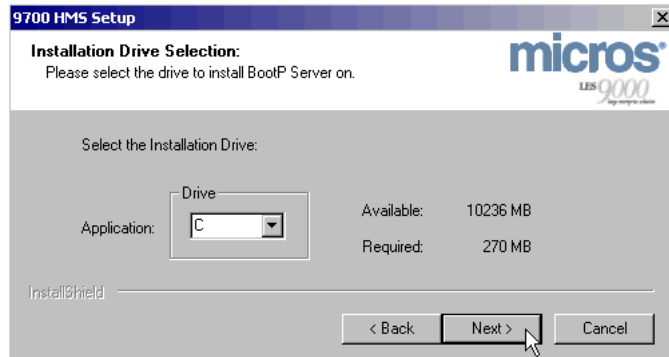

After you have selected the drive you want to install the BootP Server on, click **Next** to continue.

7. The *BootP Server Installation Summary* screen displays, seen below.

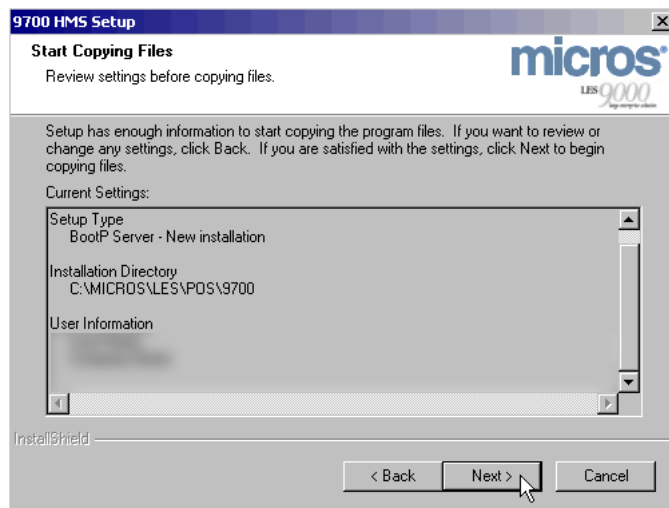

This screen provides a summary of all the parameters defined in the previous steps. Review these settings to make sure these are the correct installation parameters. Once you have verified these settings, click **Next**.

8. The installation commences. Status windows allow the user to monitor the progress of the installation. Cygwin is installed first, seen below...

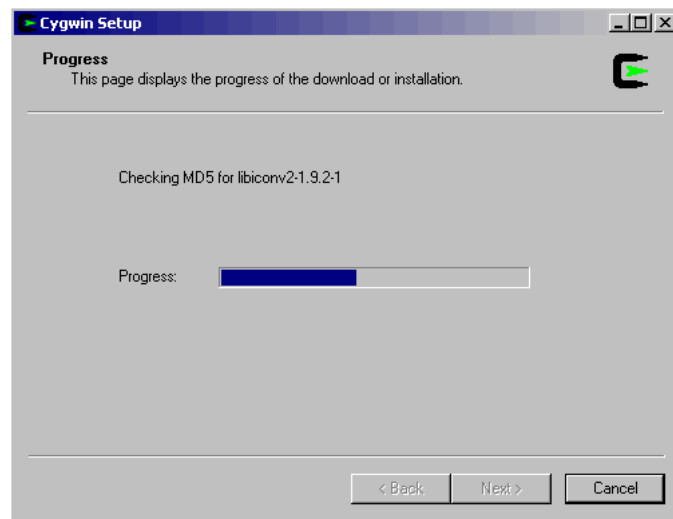

9. Once the Cygwin installation completes, the *MICROS 9700 Setup: Diskless Boot Server* screen displays, seen below.

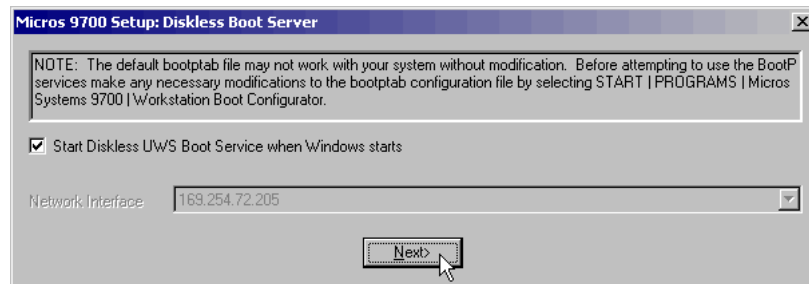

After you have read the note, decide whether you want to **Start Diskless UWS Boot Service when Windows starts**. Click **Next** to continue the installation.

10. After a few moments, the installation completes. The *InstallShield Wizard Complete* screen displays, seen below.

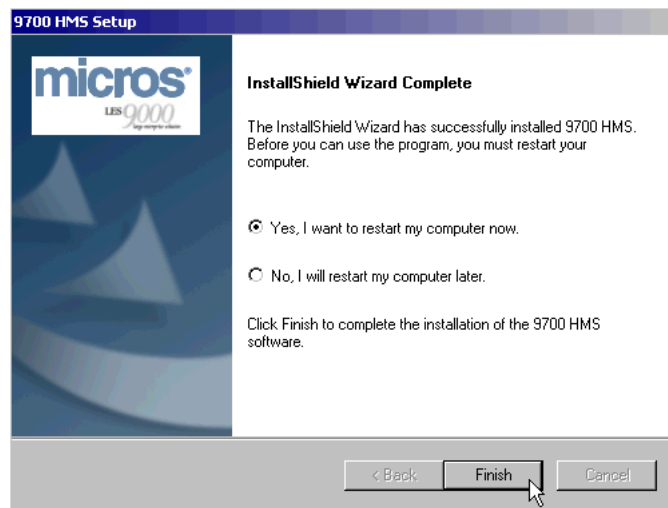

To complete the BootP Server upgrade install, select **Yes, I want to restart my computer now.**, then click **Finish**.

Upgrade the Remote Management Console (RMC) on the Clients

Note Although the 9700 application is only supported on Windows 2000 Server with SP4, or Windows Server 2003, the Remote Management Console is supported on the following operating systems for the client:

- Windows 2000
- Windows XP
- Windows Server 2003

After you have backed up the system, you are ready to upgrade the *Remote Management Console* on the clients in the system.

Follow the steps below to upgrade the 9700 *Remote Management Console* on the client. These steps must be performed on *each client* in the 9700 System.

1. Close all programs and return to the Windows Desktop.
2. On the client running the Remote Management Console, insert the 9700 System CD into the PC's CD-ROM drive. The CD automatically starts, and the 9700 HMS splash screen displays briefly...



...and then the main installation screen, the *Welcome to the InstallShield Wizard for 9700 HMS* screen displays, seen below.

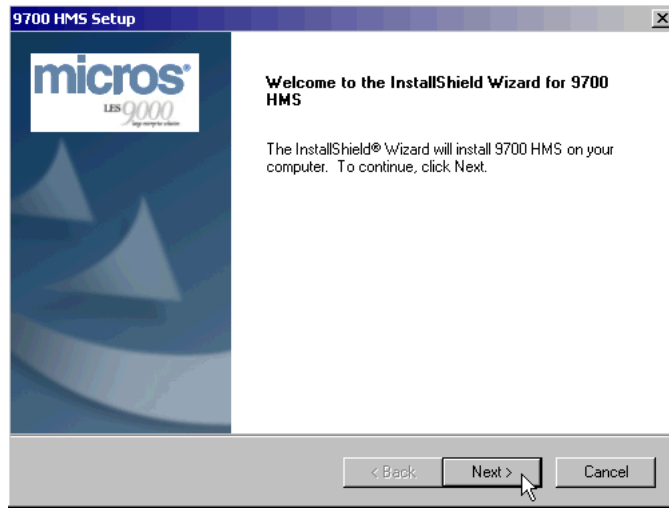

3. After reading the 9700 V. 3.0 System Setup documentation, click **Next** to continue the installation.
4. The *Remote Management Console Installation Summary* screen displays, seen below.

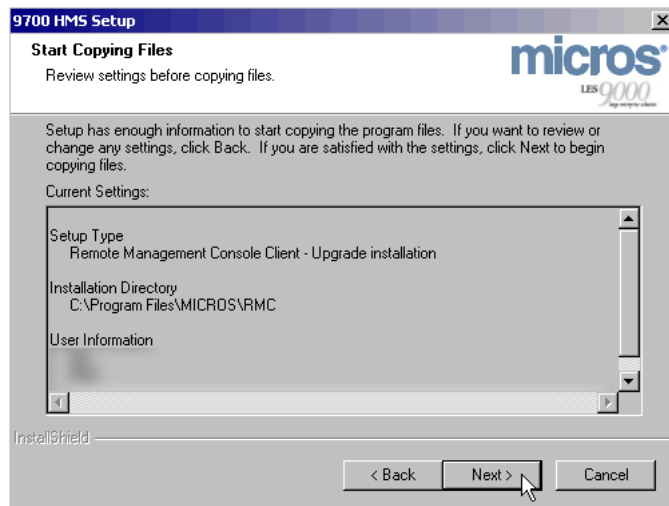

This screen provides a summary of all the parameters defined in the previous steps. Review these settings to make sure these are the correct installation parameters. Once you have tested these settings, click **Next**.

5. An installation Status message displays, seen below.

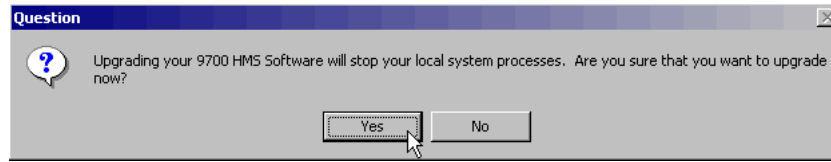

Upgrading will stop your local system processes. If you want to continue the installation click **Yes**, if not click **No**, and retry the installation at a time where system processes can be stopped.

Click **Yes** to upgrade the Remote Management Console.

6. The Remote Management Console Upgrade installation commences. Status windows allow the user to monitor the progress of the installation.

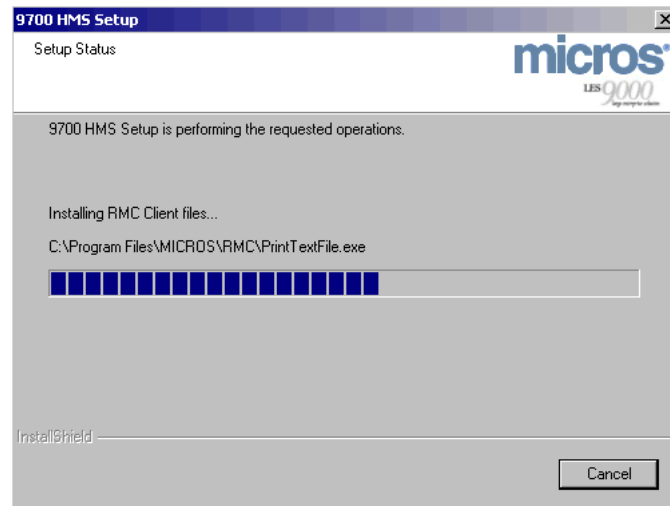

7. After a few moments, the installation completes. The *InstallShield Wizard Complete* screen displays, seen below.

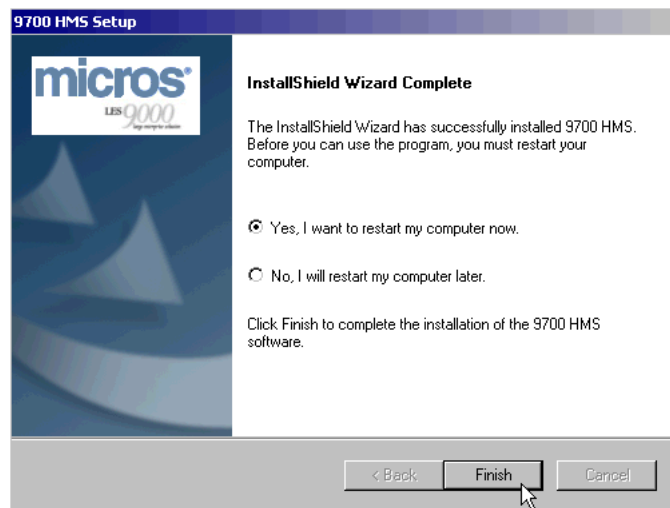

To complete the Remote Management Console upgrade install, select **Yes, I want to restart my computer now.**, then click **Finish**.

Upgrade the WinStation Client Application

If your 9700 System currently includes Winstation Clients, you will need to complete the following tasks in the order shown below to upgrade the WinStation Client application.

- ◆ Save the WinStation Configuration Settings.
- ◆ Remove the Old WinStation Application.
- ◆ Map a Network Drive to the Server.
- ◆ Install the WinStation Application.
- ◆ Replace the WinStation Configuration Settings.

***Note** This process must be repeated for each WinStation client.*

Save the WinStation Configuration Settings

1. On the *WinStation Client*, exit the *Winstation* application if it is running (select *Go to MS Windows* from the *Main Menu*).
2. Open *Windows Explorer*.
3. Go to *C:\Program Files\MICROS\WinStation Client*.
4. Copy the *Win32.ini* file to the *Windows Desktop*. This step will preserve the WinStation configuration settings. You will move this file back to its original location later.
5. Log off and then login as the administrator.
6. Proceed to *Remove the Old WinStation Application*, on page 3-74.

Remove the Old WinStation Application

1. From the Windows *Start* menu, select *Settings / Control Panel / Add/Remove Programs*.
2. Select **WinStation Client**.
3. Select **Change**. The *WinStation InstallShield Wizard* displays.
4. Select **Next**.
5. Select **Remove**.
6. Select **Next**.
7. Select **Remove**.
8. Select **Finish**.
9. Select **Close**.
10. Close the *Control Panel* and reboot the workstation.
11. Proceed to *Map a Network Drive to the Server*, below.

Map a Network Drive to the Server

1. On the *WinStation Client*, login as the administrator.
2. From the Windows *Desktop*, select *Start / Programs / Accessories / Windows Explorer*.
3. Select *Tools / Map Network Drive*.
4. Select an available drive from the drop-down list.
5. Type the following in the **Folder** field:

```
\\Server Name\MicrosClient
```

where *Server Name* is the actual name of the server to which the WinStation Client communicates.

6. Uncheck the **Reconnect at Logon** option.
7. Click **Finish**. The new network drive window displays.
8. Proceed to *Install the WinStation Application*, on page 3-75.

Install the WinStation Application

1. Navigate to \MICROS\LES\POS\9700\ClientInstalls and double-click WinStation.exe.
2. The InstallShield Wizard begins, seen below.

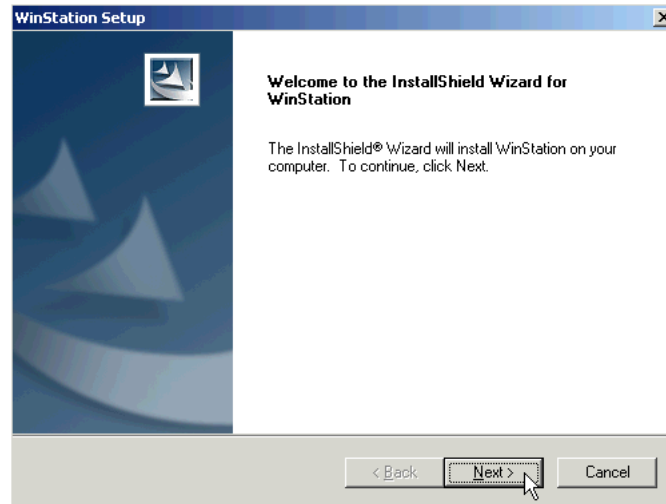

Click **Next**, to continue.

3. The *Customer Information* screen displays, seen below.

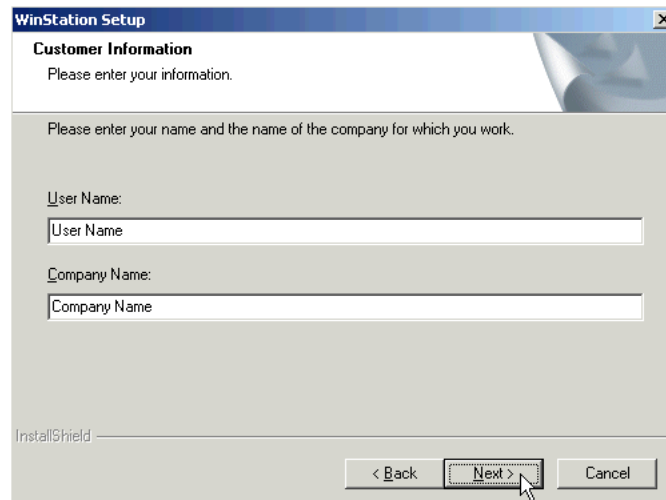
A screenshot of the 'WinStation Setup' window showing the 'Customer Information' screen. The window title is 'WinStation Setup'. The main content area has a light gray background. The text reads: 'Customer Information' and 'Please enter your information.' Below this, it says: 'Please enter your name and the name of the company for which you work.' There are two input fields: 'User Name:' with a text box containing 'User Name', and 'Company Name:' with a text box containing 'Company Name'. At the bottom, there are three buttons: '< Back', 'Next >', and 'Cancel'. A mouse cursor is pointing at the 'Next >' button.

Enter the **User Name** and **Company Name**, then click **Next** to continue.

4. The *Setup Type* screen displays (Administrator Mode Configuration seen below). Choose the appropriate setup based on the descriptions below:

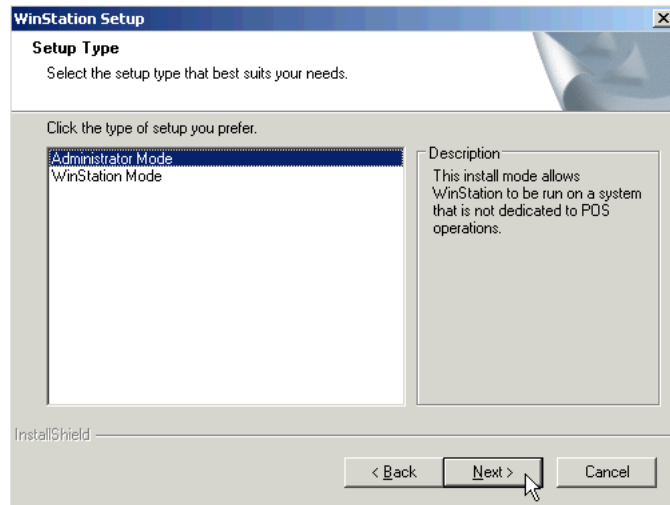

Choose WinStation Setup Type:

- ◆ **Administrator Mode -**

Select this option if you wish to have access to Windows functions as well as POS workstation functions.

- ◆ **WinStation Mode -**

Select this option if you only want POS workstation functions.

Once you have selected your WinStation Setup Type, click **Next** to continue.

5. The *Installation Drive Selection* screen displays, seen below.

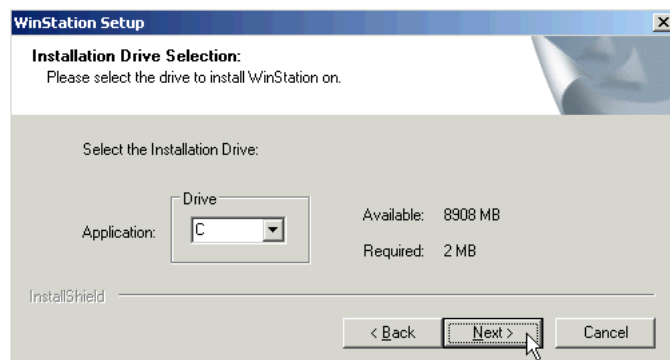

After you selected the Installation Drive, click **Next** to continue.

6. The WinStation installation summary screen displays, seen below.

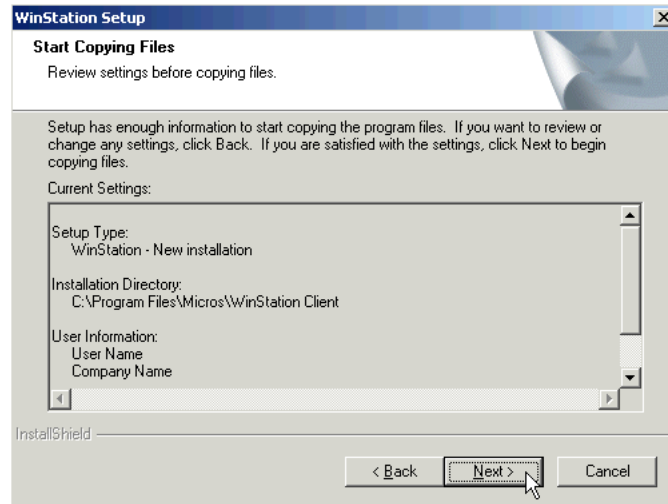

Once you have reviewed these settings, click **Next** to continue the installation.

7. After a few moments, the *InstallShield Wizard Complete* screen displays, seen below.

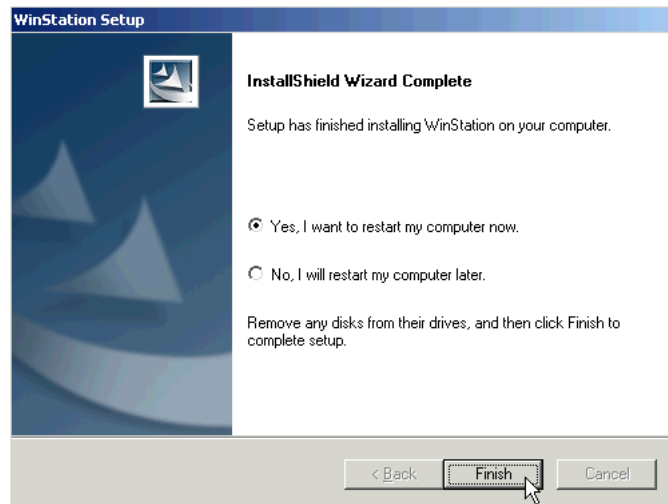

Select **Yes, I want to restart my computer now.**, then click **Finish** to complete the WinStation installation.

Replace the WinStation Configuration Settings

1. On the *WinStation Client*, start the *WinStation* application.
2. Press the touchscreen using the following keystroke sequence:
 - ♦ upper left corner
 - ♦ upper right corner
 - ♦ upper left corner

A six-digit number displays to the left of the **Access Code** field.
3. Apply the following formula to the six-digit number to calculate the Access Code:

$$\text{Digit 1} \times \text{Digit 2} + \text{Digit 4} + \text{Digit 6} = \text{Access Code}$$

For example, if the number is 374236, the formula would be
 $3 \times 7 + 2 + 6 = 29$.
4. Type the Access Code for the workstation and press **Enter**. The *Main Menu* displays.
5. Select *Go to MS Windows*.
6. Open *Windows Explorer*.
7. Move the *Win32.ini* file from the *Desktop* to *C:\Program Files\MICROS\WinStation Client*.
8. Restart the *WinStation Client* application.
9. Repeat steps 2 - 4.
10. Select *Configuration*. Select *COM Ports* and reconfigure the devices attached to the com ports on the workstation.

Index

B

Backing up the System	2-99
Bar Code Reader	1-4
Bootp Service	
Installing	2-54
Upgrading	3-64

C

Cancel a Print Job	2-69
CA/EDC	1-4
Credit Authorization	1-4
Electronic Draft Capture	1-4
Communications	1-2
Intelligent Device Network (IDN)	1-3
LAN	1-2
PMS Interface	1-2
TMS Interface	1-3

Configuring NetCCs	2-85
--------------------	------

Credit Authorization	
see CA/EDC	

E

EBUTO	2-8
see MICROS Operational Resiliency	
Eclipse PC Workstation	1-8
Electronic Draft Capture	
see CA/EDC	
Epson TM88 Thermal Printer	1-10
Epson U200B Printer	1-10

H

Hand-held Devices	
see Mobile MICROS Hand-held Terminal	

Hardware

Epson TM88 Thermal Printer	1-10
Epson U200B Printer	1-10
Recommendations	
Communication Options	1-11
Printer Options	1-7
Server Options	1-7
Terminal Options	1-7
Requirements	1-6

I

Input Devices	1-4
Bar Code Reader	1-4
Liquor Dispensing System (LDS)	
Interface	1-5

Installing the Database Server	2-11
Microsoft SQL Server 2000	2-12
Oracle 9i	2-15

Installing the 9700 HMS Application	2-19
Before you begin	2-19
9700 V. 3.0 MS-SQL	2-21 to 2-33
9700 V. 3.0 OperaPOS	2-34 to 2-45

Installing 9700 V. 3.0 Components on	
Clients	2-46
Bootp Service	2-54
Remote Enterprise Management	
Console (EMC)	2-52
Remote Management Console (RMC)	2-47

Intelligent Device Network (IDN)	1-3
Line Printers	1-3
Order Printers	1-3
Video Display Unit	1-3

K

- Keyboard Workstation 4 1-9
- KWS4 1-9

L

- LDS
 - see Liquor Dispensing System (LDS) Interface
- Line Printers 1-3
- Liquor Dispensing System (LDS) Interface 1-5
- Local Area Network (LAN) 1-2

M

- MICROS Operational Resiliency 2-8
 - Installing New 2-8
 - Upgrading EBUTO to 2-9
- Microsoft SQL Server 2000 (SP3) 2-11
 - Installing 2-12
- Mobile MICROS Hand-held Terminal 1-9
- MS-SQL Maintenance Plans 2-99
 - MCRSPOS SQL Simple User DB
 - Maintenance Plan 2-101 to 2-103
 - MCRSPOS SQL User DB
 - Maintenance Plan 2-104 to 2-109
 - MCRSPOS SQL User Reorganize Data
 - Maintenance Plan 2-110 to 2-112
- Multiple Network or Local Printers 2-66

N

- NetCCs
 - Adding to the 9700 System 2-88 to 2-91
 - Before you Begin 2-87
 - CC Table Fields for use with 8700sql 2-97
 - configuring 2-85
 - Description 1-11
 - NetCC/RCC Setup for MICROS
 - Operational Resiliency
 - Pair-Example 2-96
 - NetCC/RCC Setup-Example 2-95
 - Troubleshooting 2-92 to 2-94
- Network and Local Printing
 - Configuring 2-60
 - Printing in the Enterprise
 - Management Console (EMC) 2-61
 - TCP/IP 2-60
 - Configuring Multiple Printers 2-66
 - Configuring the Device Table 2-68
 - Configuring the Device Table 2-67

O

- Oracle 9i 2-11
 - Installing 2-15
- Order Printers 1-3

P

- PMS 1-2
- PostScript Printers 2-10
- Printer Network
 - Line Printers 1-3
 - Order Printers 1-3
 - Video Display Units 1-3
- Printers
 - Cancel a Print Job 2-69
 - cancel a print job 2-69
 - Epson TM88 1-10
 - Epson U200B 1-10
 - Postscript 2-10
 - Sample Printer Files 2-62
 - Editing 2-63
 - On the Server 2-62
 - Testing Printing Options 2-69
 - Printing in the 9700 Configurator 2-61

Property Management System Interface
see PMS

R

Remote Enterprise Management Console (EMC)
Installing 2-52
Using 2-53

Remote Management Console (RMC)
Installing 2-47
Upgrading 3-69

S

Sample Printer Files 2-62

Software Licensing 2-2

Starting the 9700 System 2-59

System Security 2-3
Groups and Members/Passwords
File Permissions for Member Server
and Workgroup Configuration 2-7
9700 Installed in a Workgroup 2-6
9700 Installed on a Domain
Controller 2-5
9700 Installed on a Member Server 2-5
Groups and Users/Passwords
Domain Controller or Member Server 2-3
Workgroup 2-4

T

Table Management System Interface
see TMS

TCP/IP
printing 2-60

Testing Printing Options 2-69

TMS 1-3

U

Upgrading MICROS Peripheral Applications 3-63
Bootp 3-64
Remote Management Console (RMC) 3-69
WinStation 3-73

Upgrading to 9700 V. 3.0 3-2

MS-SQL Upgrades 3-3
Previous Version of 9700 Using
Existing Server 3-4 to 3-15
Before You Begin 3-4
Upgrade Procedure 3-4
Previous Version of 9700 Using
New Server 3-16 to 3-23
Before you Begin 3-16
Upgrade Procedure 3-16
8700 to 9700 Using
New Server 3-24 to 3-32
Before you Begin 3-24
Upgrade Procedure 3-24

Oracle Upgrades 3-33
Previous Version of 9700 Using Existing
Server 3-34 to 3-45
Before you Begin 3-34
Upgrade Procedure 3-34
Previous Version of 9700 Using New
Server 3-46 to 3-53
Before you Begin 3-46
Upgrade Procedure 3-46
8700 to 9700 Using New Server 3-54 to
3-62
Before you Begin 3-54
Upgrade Procedure 3-54

V

VDU 1-3

Video Display Unit
see VDU

W

Windows
Installing 2-2
Post Install Setup 2-8

Index

WinStation	
Benefits	2-71
Client Security	2-74
Configure the Server	2-80
Configure the Workstation	2-81
Configuring	2-70 to 2-81
Fields, Security Options, and Function Buttons	2-75
Installing	2-76
Peripheral Support	2-72
Requirements	2-71
Touchscreen Icons	2-76
Upgrading	3-73
WinStation Client Application	2-70
security	2-74
touchscreen icons	2-70
Workstation 4	1-8
Workstations	
Configuring as a WinStation client	2-70
Configuring Workstation 4 (WS4) Clients	2-82
Configure the Client	2-84
Install the Serial Application Loader (SAL) Software	2-82
Modifying the Configuration Overlay File (uws3.cfg)	2-83
Performing the Confidence Test	2-83
Eclipse	1-8
Keyboard Workstation 4 (KWS4)	1-9
Workstation 4 (WS4)	1-8
WS4	
Configuring	2-82
Client Workstation	2-84
install the SAL software	2-82
Modifying the Configuration Overlay File (uws3.cfg)	2-83
Performing the Confidence Test	2-83

Numerics

9700 HMS V. 3.0	
Installing	2-19
Upgrades	3-2
9700 System	
Backing up the System	2-99
Input Devices	1-4
starting	2-59